



# ***SAFEWAZE***

**FALL PROTECTION'S MOST RESPONSIVE PARTNER**



**2024 PRODUCT CATALOG**

**Safewaze is a beacon of light in a dark landscape of manufacturing. It's nice to know there are companies out there still hustling to be responsive.**

**Scott Wood**  
*Inventory Manager*  
*Hawkins-Graves Inc.*



**SAFEWAZE**





SAFEWAZE  
NORTHSTAR

SAFEWAZE

# DELIVERING EXACTLY **WHAT YOU WANT,** THE **WAY** YOU WANT IT

## WELCOME

As fall protection's most responsive partner, first – we listen.

Then we respond quickly with versatile solutions. No matter how tough the job or challenging the jobsite, we help create the perfect plan for your unique needs.

With 150+ years of safety experience, we deliver quality equipment from our U.S. facility with expert training and dedicated support.

Safewaze is on a mission to protect the lives and livelihoods of all workers at height. Thank you for trusting us to protect yours.

## DEEPLY INVESTED

We remain invested in the safety of your workers as we build a stronger Safewaze.

Advances continue in lean manufacturing, quality management and training resources as well as R&D with a new 4-story testing lab.

From solution-oriented sales professionals to the most responsive customer service in the industry, our team is paving the way for your success.

## OUR STORY

Safewaze was born in NC in 1994 and has become the #1 growing fall protection brand by pushing boundaries.

Now as a division of Canopy Brands, we continue to grow by challenging the traditional provider experience.

TRUSTED FAMILY OF AT-HEIGHT BRANDS

**CANOPY**  
BRANDS

ISO 9001:2015 Certified, Quality Management; Orion Registrar, Inc.



## INDUSTRIES

We proudly serve America's trade professionals wherever they work at height.



AGRICULTURE



CONSTRUCTION



MINING



OIL & GAS



PLANTS & FACTORIES



SOLAR & WIND ENERGY



TOWER & UTILITIES



WAREHOUSES



# TEAM OF EXPERTS

When you need answers, we listen first. Then our team offers practical solutions and products that **will keep your team safe**. Just ask us!

## REGIONAL SALES



**Ryan Fusco**  
Sales Manager, Mid-Atlantic  
ryan@safewaze.com



**Stephen Hartsell**  
VP Sales  
stephen@safewaze.com



**David Marks**  
Sales Manager, Northeast  
dmarks@safewaze.com



**Dave Molendyk**  
Sales Manager, West  
dave@safewaze.com



**Roger Ramstack**  
Sales Manager, Southeast  
rogerr@safewaze.com



**Chris Salisbury**  
Sales Manager, Southwest  
chris@safewaze.com



**Phil Schaser**  
Sales Manager, Midwest  
phil@safewaze.com



**Gene Verble**  
Chairman  
gene@safewaze.com



**Christian Zeagler**  
Sales Manager, Florida |  
Key Accounts  
czeagler@safewaze.com

## CUSTOMER SUPPORT



**Sandra Baucom**  
Customer Service  
Representative  
sandra@safewaze.com



**Katie McBride**  
Customer Service Associate  
kmcbride@safewaze.com



**Frankie Smith**  
Customer Service Associate  
fsmith@safewaze.com



**Melissa Smith**  
Customer Service Supervisor  
melissa@safewaze.com



**Michael Gledhill**  
Sales Support Associate  
michael@safewaze.com



**Trena Shutters**  
Sales Support Lead  
trena@safewaze.com



**Amy Simpson**  
Sales Support Associate  
asimpson@safewaze.com



**Jorge Acevedo**  
Technical Support Specialist  
jorge@safewaze.com



**Tyler Kyles**  
Technical Support Specialist  
tyler@safewaze.com



# ***SAFEWAZE***

## **TABLE OF CONTENTS**

<b>ANCHORS</b>	<b>8</b>
<b>HARNESSES</b>	<b>32</b>
<b>LANYARDS</b>	<b>70</b>
<b>SELF-RETRACTING LIFELINES</b>	<b>104</b>
<b>VERTICAL LIFELINES</b>	<b>132</b>
<b>HORIZONTAL LIFELINES</b>	<b>142</b>
<b>LADDER CLIMB SYSTEMS</b>	<b>158</b>
<b>CONFINED SPACE</b>	<b>168</b>
<b>RESCUE</b>	<b>178</b>
<b>TOOL LANYARDS</b>	<b>188</b>
<b>KITS &amp; COMBOS</b>	<b>196</b>
<b>ACCESSORIES</b>	<b>208</b>
<b>MATERIAL HANDLING</b>	<b>214</b>

## **HEADQUARTERS**

225 Wilshire Avenue SW  
Concord, NC 28025

**Purchase Orders:**  
[orders@safewaze.com](mailto:orders@safewaze.com)

**Customer Service:**  
[info@safewaze.com](mailto:info@safewaze.com)

**Hours: 8AM – 5PM ET**  
**Monday to Friday**





# ANCHORS

Anchors are the foundation of fall protection: These attachment points must sustain a fallen worker under the tremendous forces generated during a drop. From the mobile convenience of a strap anchor to the cast-in-place security of a concrete post anchor, Safewaze has the support you need.



## ROOFING ANCHORS

Anchor point solutions for fall arrest systems on roofs. Used in maintenance work, repair and new construction jobs. Offered in both temporary and permanent designs.



## CONCRETE ANCHORS

Anchor element cast in place or post-installed into hardened concrete which can be used to transmit loads to the concrete. Offered in both temporary and permanent designs.



## STEEL ANCHORS

Fall protection anchor points designed to be attached to I-beams and other structural steel members. Offered in a wide variety of portable, bolted and welded solutions.



## STRAP ANCHORS

A selection of non-penetrating lightweight anchor solutions that are easy to use, mobile and meet the needs of a wide variety of job site situations.



## SPECIALTY ANCHORS

Specialized anchor points designed to offer unique solutions to various fall arrest applications.

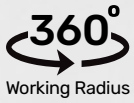

## MEMBRANE ANCHOR 022-4090

The Membrane Anchor offers easy drop-through installation from the roof surface. Features a 360° working radius and a 4" elevated anchor point to prevent wear and tear from connections dragging on the surface.

- No access to underside of roof required with easy drop-through installation
- Elevated eye bolt (4") prevents abrasion
- 360° working radius increases efficiency
- Permanent single point anchor
- Use with lanyards, SRLs and VLLs (not for use with HLL)
- Fits roof thicknesses from 3" to 12"
- Minimum Breaking Strength: 3,600 lbs.
- Weight Capacity ANSI 130-310 lbs.
- OSHA 1926.502, 1910.140, 1910.66



Easy Drop-Through Installation



Secures in Place Automatically

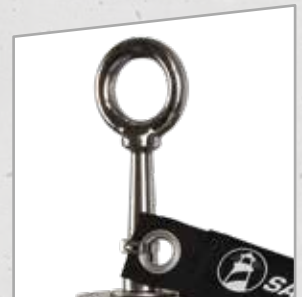

Elevated Eye Bolt Protects Roof





### 360° Roof Anchor

**019-4010**

- Temporary and reusable
- Used on wood roofs
- Includes [6] 1/4" x 3" stainless lag screws for installation
- Minimum Breaking Strength: 5,000 lbs.
- Weight Capacity ANSI 130-310 lbs., OSHA 420 lbs.
- OSHA 1926.502, 1910.140, 1910.66



### Chain Anchor

**018-4000**

- O-ring connection point
- Durable steel chain
- Reinforced synthetic strap
- Easily installs with [6] 5/16" x 3" lag bolts (included) or [12] 16D nails (not included)
- Minimum Breaking Strength: 5,000 lbs.
- Weight Capacity ANSI 130-310 lbs., OSHA 420 lbs.
- OSHA 1926.502, 1910.140, 1910.66



### Ring Anchor

**FS-EX310-1**

- Reusable anchor for wood roofs
- Includes [3] 5/16" x 3" hex lag screw
- Minimum Breaking Strength: 5,000 lbs.
- Weight Capacity ANSI 130-310 lbs., OSHA 420 lbs.
- ANSI Z359.18-2017 Type A, OSHA 1926.502, 1910.140



### Reusable Roof Anchor

**FS870**

- Installed on peak or flat wood and metal decking roofs
- Hinged construction for adjustment to different angles
- Corrosion-resistant plated steel
- Large D-ring connection point
- Minimum Breaking Strength: 5,000 lbs.
- Weight Capacity ANSI 130-310 lbs., OSHA 420 lbs.
- OSHA 1926.502, 1910.140, 1910.66

#### Reusable Roof Anchor Options

Part Number	Description
FS870	Reusable Roof Anchor
FS870N	Reusable Roof Anchor, 20pc Nails
021-4065	20pc 16D Roofing Nails for FS870
FS870S	Reusable Roof Anchor, 12pc Sheet Metal Screws
021-4066	12pc 2.5" Sheet Metal Screws for FS870



**Knock-Down Roof Anchor  
FS871**

- Knockdown, disposable design
- Installs on pitched wood roofs
- Minimum Breaking Strength: 3,600 lbs.
- Weight Capacity ANSI 130-310 lbs.
- OSHA 1926.502, 1910.140, 1910.66

**Knock Down Roof Anchor Options**

Part Number	Description
FS871	Knock-Down Roof Anchor
FS871-25	Knock-Down Roof Anchor: Pack 25
FS871N	Knock-Down Roof Anchor, 8pc Nails
021-4067	8pc 16D Roofing Nails for FS871



**Wood Truss/Attic Anchor  
021-4042**

- Unique anchor solution for overhead use
- Lightweight, easy installation and removal
- Corrosion-resistant zinc-plated steel
- Includes [10] #12 x 1.5" zinc-plated wood screws
- Minimum Breaking Strength: 1,800 lbs.
- Weight Capacity ANSI 130-310 lbs.
- OSHA 1926.502, 1910.140, 1910.66



**FrogLink Temporary Roof Anchor  
019-4005**

- 360° working radius
- Built-in energy absorber reduces damage to structure
- Easily attaches with [7] 14 gauge 75 mm long roofing screws (not included)
- Durable stainless steel construction
- Minimum Breaking Strength: 5,000 lbs.
- Weight Capacity ANSI 130-310 lbs.
- ANSI Z359.18-2017 Type D, OSHA 1926.502, 1910.140, 1910.66



**Standing Seam Roof Anchor  
FS-EX311**

- Easy to install, reusable and non-penetrating
- Designed for sloped or flat standing seam roofs
- Accommodates a wide range of standing seams
- Minimum Breaking Strength: 3,600 lbs.
- Weight Capacity ANSI 130-310 lbs.
- OSHA 1926.502, 1910.140, 1910.66



**Standing Seam SRL Swivel Anchor**  
**023-4095**

- Easy to install, reusable and non-penetrating
- For flat or pitched roofs minimum gauge 26
- Adjustable crossarm spans 24-40"
- 360° swivel base accommodates most SRLs
- Attach SRLs to post, no disassembly required
- D-ring connection for EA lanyards, VLLs and HLLs
- Minimum Breaking Strength: 3,600 lbs. (16 kN)
- Includes [6] S-5-U clamps
- System Capacity: 1 user as single point, 2 users/span for HLLs
- Weight Capacity ANSI 130-310 lbs., OSHA 420 lbs.
- OSHA 1926.502, 1910.140, 1910.66



**Standing Seam Swivel Anchor**  
**023-4096**

- Easy to install, reusable and non-penetrating
- Designed for flat or pitched roofs
- Adjustable crossarm spans 24-40"
- 360° swivel D-ring connection point for SRL-Ps, energy absorbing lanyards and VLLs (not for use with HLLs)
- Includes [4] S-5-U clamps
- System Capacity: 1 user maximum
- Weight Capacity ANSI 130-310 lbs., OSHA 420 lbs.
- OSHA 1926.502, 1910.140, 1910.66



**12" Post Anchor**  
**FS-EX325**

- For use on wood, steel, and concrete
- Corrosion-resistant galvanized coating
- Minimum Breaking Strength: 5,000 lbs.
- Weight Capacity ANSI 130-310 lbs., OSHA 420 lbs.
- OSHA 1926.502, 1910.140, 1910.66

**Post Anchor Options**

Part Number	Description
FS-EX325	12" Post Anchor
FS-EX326	18" Post Anchor



**4-Point Plate Anchor**  
**021-4076**

- Increased range with 4 steel loop connection points
- Versatile use as single anchor point or with HLL system
- Easy to install, reusable and temporary
- For use on wood, steel and concrete
- Weight Capacity ANSI 130-310 lbs., OSHA 420 lbs.
- Minimum Breaking Strength: 5,000 lbs.
- OSHA 1926.502, 1910.140, 1910.66



**S-5-U Clamp**  
**023-4101**

- Replacement S-5-U clamp for 023-4095 or 023-4096



### FrogLink Permanent Roof Anchor with Rivets

#### 019-4006

- 360° working radius
- Built-in energy absorber reduces damage to structure
- Durable stainless steel construction
- Minimum Breaking Strength: 3,600 lbs.
- Weight Capacity ANSI 130-310 lbs.
- OSHA 1926.502, 1910.140, 1910.66



### Hand Rivet Tool

#### 019-21001

- Designed for installing height safety anchor points
- Manual operated rivet gun
- Compact lightweight design
- Durable and reliable

#### Hand Rivet Tool Options

Part Number	Description
019-21001	Hand Rivet Tool
020-16001	Replacement Rivets



### Peak Roof Anchor

#### 020-4025

- Installs easily on roof peak
- Dual D-ring for easy access to both sides of the peak
- Low profile, minimalistic design
- Constructed with durable stainless and zinc-plated steel
- [10] 16D Roofing nails included
- Minimum Breaking Strength: 5,000 lbs.
- Weight Capacity ANSI 130-310 lbs., OSHA 420 lbs.
- OSHA 1926.502, 1910.140, 1910.66



### Permanent Roof Anchor

#### 020-4026

- Installs easily between roof peak and eaves
- Low profile, minimalistic design
- Constructed with durable stainless and zinc-plated steel
- [14] 16D Roofing nails included
- Minimum Breaking Strength: 5,000 lbs.
- Weight Capacity ANSI 130-310 lbs., OSHA 420 lbs.
- OSHA 1926.502, 1910.140, 1910.66



**Ridge Roof Anchor**  
**020-4027**

- Installs easily between roof peak and eaves
- Low profile, minimalistic design
- Constructed with durable stainless and zinc-plated steel
- [8] 16D Roofing nails included
- Minimum Breaking Strength: 5,000 lbs.
- Weight Capacity ANSI 130-310 lbs., OSHA 420 lbs.
- OSHA 1926.502, 1910.140, 1910.66



**SRL Swivel Roof Anchor**  
**022-4084**

- Installs easily on Z-purlin, metal decking or wood roof
- Also installs on flat concrete 3000 PSI or higher
- 360° swivel base accommodates most SRLs
- Attach SRLs to post – no disassembly required
- D-ring connection for EA lanyards, VLLs and HLLs
- Temporary and reusable for cost efficiency
- Includes [8] lag screws for wood and [16] self-tapping screws for metal
- Minimum Breaking Strength: 5,000 lbs.
- Weight Capacity ANSI 130-310 lbs., OSHA 420 lbs.
- OSHA 1926.502, 1910.140, 1910.66



**TileLink Anchor (Screws)**  
**022-4092**

- Installs under tiles—no cutting sarking
- Discreet low profile with only connection exposed
- Temporary or permanent installation into wooden truss
- Built-in energy absorber reduces damage to structure
- Includes [5] 14 gauge 55mm hex head screws with seal
- Suitable for roofs with pitch up to 7/12
- Minimum Breaking Strength: 3,600 lbs.
- Weight Capacity ANSI 130-310 lbs.
- OSHA 1926.502, 1910.140, 1910.66

**TileLink Anchor Options**

Part Number	Description
022-4092	TileLink Anchor (Screws)
022-4094	TileLink Anchor (Rivets)

## REMOVABLE CONCRETE ANCHOR

022-4085

The Removable Concrete Anchor is a compact, durable anchor for repeated use in concrete. Easy installation in seconds with quick trigger removal by hand or optional assist with a simple tap. Secure protection while you work and releases quickly when you need to move on.

- Removable and reusable with reliable durability
- 360° rotating connection point for increased mobility
- Easy trigger provides quick release for repeated use
- Durable cap for optional hammer assisted removal
- For horizontal, vertical and overhead use including with HLLs
- 3/4"x 3" drilled hole required for installation
- Length: 6.5"
- Minimum Breaking Strength:
  - 5,000 lbs. (in 3,000 PSI concrete)
  - 10,000 lbs. (in 4,000 PSI or higher concrete)
- Weight Capacity ANSI 130-310 lbs., OSHA 420 lbs.
- ANSI Z359.18-2017 Type T, OSHA 1926.502, 1910.140, 1910.66



Easy Trigger with Cap



Corrosion-Resistant Materials



360° Rotation







### 5K Swivel Anchor & Concrete Wedge Bolt

#### 021-4054

- 180° / 360° rotating connection point for increased mobility
- Quick temporary or permanent installation
- Versatile vertical or horizontal use
- Fits in 1/2" (12.7mm) concrete hole
- Minimum Breaking Strength: 5,000 lbs.
- Weight Capacity ANSI 130-310 lbs., OSHA 420 lbs.
- ANSI Z359.18-2017 Type A, OSHA 1926.502, 1910.140, 1910.66

#### 5K Swivel Anchor & Concrete Wedge Bolt Options

Part Number	Description
021-4054	5K Swivel Anchor & Concrete Wedge Bolt
021-4057	5K Replacement Concrete Wedge Bolt



### 10K Swivel Anchor & Concrete Wedge Bolt

#### 021-4072

- 180° / 360° rotating connection point for increased mobility
- Quick temporary or permanent installation
- Versatile vertical or horizontal use
- Fits in 5/8" (15.9mm) concrete hole
- Minimum Breaking Strength: 10,000 lbs.
- Weight Capacity ANSI 130-310 lbs., OSHA 420 lbs.
- ANSI Z359.18-2017 Type A, OSHA 1926.502, 1910.140, 1910.66

#### 10K Swivel Anchor & Concrete Wedge Bolt Options

Part Number	Description
021-4072	10K Swivel Anchor & Concrete Wedge Bolt
021-4073	10K Replacement Concrete Wedge Bolt



### 5K Swivel Anchor & Concrete Bolt

#### 021-4052

- 180° / 360° rotating connection point for increased mobility
- Quick temporary or permanent installation
- Versatile vertical or horizontal use
- Galvanized 0.5" x 6" concrete bolt
- Minimum Breaking Strength: 5,000 lbs.
- Weight Capacity ANSI 130-310 lbs., OSHA 420 lbs.
- ANSI Z359.18-2017 Type A, OSHA 1926.502, 1910.140, 1910.66

#### 5K Swivel Anchor & Concrete Wedge Bolt Options

Part Number	Description
021-4052	5K Swivel Anchor & Concrete Bolt
021-4053	Replacement Concrete Bolt



**5K Removable Concrete Hole Anchor  
FS876**

- Removable and reusable with reliable durability
- Easy trigger provides quick release for repeated use
- 3/4"x 3" drilled hole required for installation
- Length: 10.75"
- Minimum Breaking Strength: 5,000 lbs.
- Weight Capacity ANSI 130-310 lbs., OSHA 420 lbs.
- OSHA 1926.502, 1910.140, 1910.66



**5K Swivel D-ring Anchor Assembly  
021-4081**

- Swivels with 180° / 360° rotation
- Quick temporary or permanent installation
- Used vertically or horizontally
- Minimum Breaking Strength: 5,000 lbs.
- Weight Capacity ANSI 130-310 lbs., OSHA 420 lbs.
- ANSI Z359.18-2017 Type A, OSHA 1926.502, 1910.140, 1910.66

**5K Swivel D-ring Anchor Options**

Part Number	Description
021-4081	5K Swivel D-ring Anchor Assembly
021-4082	5K Swivel D-ring Anchor (no fastener)
021-4083	5K Swivel D-ring Anchor Bushing/Washer Set



**18" Post Anchor, Concrete  
020-4029**

- 18" fixed steel anchor point
- Cast-in-place concrete installation
- Corrosion-resistant galvanized coating
- Weight Capacity ANSI 130-310 lbs., OSHA 420 lbs.
- OSHA 1926.502, 1910.140, 1910.66



### Concrete Anchor Strap FS880

- Constructed with heavy duty webbing with wear sleeve
- D-ring connection point
- Loop end for easy installation
- Minimum Breaking Strength: 5,000 lbs.
- Weight Capacity ANSI 130-310 lbs., OSHA 420 lbs.
- ANSI Z359.18-2017 Type A, OSHA 1926.502, 1910.140, 1910.66

#### Concrete Anchor Strap Options

Part Number	Description
FS880	4' Concrete Strap
FS880-1	1' Concrete Strap
FS880-6	6' Concrete Strap
FS880-8	8' Concrete Strap
FS880-10	10' Concrete Strap



### Concrete Anchor Strap: Soft Loop 70180

- Constructed with heavy duty webbing with wear sleeve
- Reinforced web loops at each end
- Loop ends for easy installation
- Minimum Breaking Strength: 5,000 lbs.
- Weight Capacity ANSI 130-310 lbs., OSHA 420 lbs.
- ANSI Z359.18-2017 Type A, OSHA 1926.502, 1910.140, 1910.66

#### Concrete Anchor Strap Options

Part Number	Description
70180	4' Concrete Strap: Soft Loop
70200	6' Concrete Strap: Soft Loop
70280	8' Concrete Strap: Soft Loop
70300	10' Concrete Strap: Soft Loop
70380	15' Concrete Strap: Soft Loop

**BEAM WALKER EASY SLIDER**  
021-4068

The Beam Walker Easy Slider offers smooth trailing plus hands-free mobility. This lightweight compact design can be used with one-handed trigger action and dual adjustment.

- 180° rotating connection point
- Nylon rollers for more effective slide
- Replaceable jaw liners extend product life
- Easy trigger for quick lock & release
- Lightweight aluminum construction
- Overhead and foot level tie-off
- Overall Length: 19.5"
- Beam Flange Thickness: Up to 1.25"
- Minimum Breaking Strength: 5,000 lbs.
- Weight Capacity ANSI 130-310 lbs., OSHA 420 lbs.
- ANSI Z359.18-2017 Type A, OSHA 1926.502, 1910.140, 1910.66



Nylon Roller



180° Connection



Easy Trigger

**Beam Walker Easy Slider Sizes**

Part Number	Description
021-4068	Beam Walker Easy Slider 3-1/2"-14"
021-4069	Beam Walker Easy Slider 12"-30"
021-4071	Replacement 2 Jaws w/4 Fasteners (for 021-4068)
021-4074	Replacement 2 Jaws w/4 Fasteners (for 021-4069)

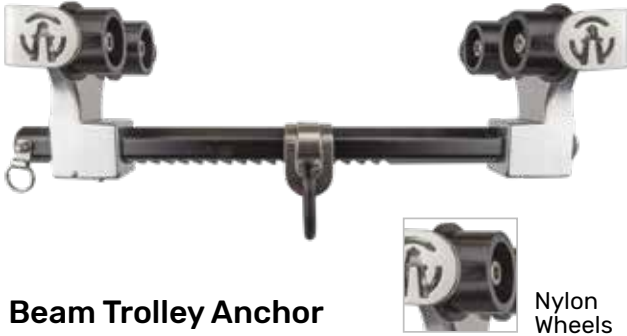

**Beam Trolley Anchor**  
**018-4001**

- Lightweight aluminum body
- Stainless steel rail guides
- Coated steel D-ring attachment point
- Abrasion, heat & chemical resistant nylon wheels
- Beam Flange Width Range: 3.5"-14"
- Beam Flange Thickness: Up to 1.75"
- Minimum Breaking Strength: 5,000 lbs.
- Weight Capacity ANSI 130-310 lbs., OSHA 420 lbs.
- OSHA 1926.502, 1910.140, 1910.66, CE 0321, EN 795:1996 (+A1:2000) Class B



**Vertical/Stationary Beam Anchor**  
**019-4009**

- Easy installation and use
- Lightweight aluminum construction
- Rotating connection point
- Beam Flange Width Range: 3.5"-14"
- Minimum Breaking Strength: 5,000 lbs.
- Weight Capacity ANSI 130-310 lbs., OSHA 420 lbs.
- OSHA 1926.502, 1910.140, 1910.66



**Sliding Beam Anchor 3.5-15"**  
**021-4075**

- 180° rotating connection point
- Nylon rollers for more effective slide
- Replaceable jaw liners extend product life
- Single sided adjustment
- Easy trigger for quick lock & release
- Lightweight aluminum construction
- Beam Flange Thickness: Up to 1.25"
- Minimum Breaking Strength: 5,000 lbs.
- Weight Capacity ANSI 130-310 lbs., OSHA 420 lbs.
- ANSI Z359.18-2017 Type A, OSHA 1926.502, 1910.140, 1910.66



**Premier Sliding Beam Anchor**  
**021-4055**

- 180°/360° swivel connection point
- Reinforced jaw liners for smooth sliding action
- Dual adjustment with jaws on both ends
- Easy trigger for quick lock & release
- Lightweight aluminum construction
- Beam Flange Width Range: 4"-13"
- Beam Flange Thickness: Up to 1.25"
- Minimum Breaking Strength: 5,000 lbs.
- Weight Capacity ANSI 130-310 lbs., OSHA 420 lbs.
- ANSI Z359.18-2017 Type A, OSHA 1926.502, 1910.140, 1910.66



**D-Bolt Anchor**

**FS887**

- Fits rated structures 3" or less
- Dimensions: 4.5" W x 3" H
- Minimum Breaking Strength: 5,000 lbs.
- Weight Capacity ANSI 130-310 lbs., OSHA 420 lbs.
- OSHA 1926.502, 1910.140, 1910.66



**Bolt On D-Ring Anchor**

**FS888**

- D-ring moves freely after installation
- Can be bolted or welded on
- Dimensions: 1/4" x 2" x 4-1/2"
- Minimum Breaking Strength: 5,000 lbs.
- Weight Capacity ANSI 130-310 lbs., OSHA 420 lbs.
- OSHA 1926.502, 1910.140, 1910.66



**Girder Grip Anchor**

**019-4007**

- For metal and steel structures
- Used horizontally or vertically
- Fits hole diameter 13/16" min. to 1-1/4"
- Installs in steel with max thickness of 1-1/4"
- Dimensions: 0.25" x 2" x 4.5"
- Minimum Breaking Strength: 5,000 lbs.
- Weight Capacity ANSI 130-310 lbs., OSHA 420 lbs.
- OSHA 1926.502, 1910.140, 1910.66



**18" Post Anchor - I-Beam**

**020-4030**

- Temporary steel anchor point
- For use on I-beams up to 10"
- Corrosion-resistant galvanized coating
- Base Dimensions: 12" x 12"
- Minimum Breaking Strength: 5,000 lbs.
- Weight Capacity ANSI 130-310 lbs., OSHA 420 lbs.
- OSHA 1926.502, 1910.140, 1910.66



### 10K Swivel Steel Anchor & Puck Assembly

#### 021-4048

- 180° / 360° rotating connection point
- Built with heavy duty forged steel
- Easy weld on puck plus 5/8" fastener
- Minimum Breaking Strength: 10,000 lbs.
- Weight Capacity ANSI 130-310 lbs., OSHA 420 lbs.
- ANSI Z359.18 Type A, OSHA 1926.502, 1910.140, 1910.66

#### 10K Swivel Steel Anchor & Puck Options

PART NUMBER	DESCRIPTION
021-4048	10K Swivel Steel Anchor & Puck Assembly
021-4041	10K Steel Puck & Bolt
021-4040	10K Swivel Anchor Bolt



### 10K Swivel Steel Anchor

#### 021-4044

- 180° / 360° rotating connection point
- Engineered for superior durability
- Flexibility with fastener method
- Minimum Breaking Strength: 10,000 lbs.
- Weight Capacity ANSI 130-310 lbs., OSHA 420 lbs.
- ANSI Z359.18 Type A, OSHA 1926.502, 1910.140, 1910.66



### 5K Swivel Steel Anchor & Puck Assembly

#### 021-4059

- 180° / 360° rotating connection point
- Heavy duty, corrosion-resistant
- Easy weld on puck plus 1/2" fastener
- Minimum Breaking Strength: 5,000 lbs.
- Weight Capacity ANSI 130-310 lbs., OSHA 420 lbs.
- ANSI Z359.18-2017 Type A, OSHA 1926.502, 1910.140, 1910.66

#### 5K Swivel Steel Anchor Options

PART NUMBER	DESCRIPTION
021-4059	5K Swivel Steel Anchor & Puck Assembly
021-4064	5K Steel Puck & Bolt



**5K Swivel Steel Anchor & Bolt**  
**021-4047**

- 180° / 360° rotating connection point
- Installs quickly with 1/2" fastener
- Temporary or permanent
- Vertical or horizontal use
- Minimum Breaking Strength: 5,000 lbs.
- Weight Capacity ANSI 130-310 lbs., OSHA 420 lbs.
- ANSI Z359.18-2017 Type A, OSHA 1926.502, 1910.140, 1910.66

**5K Swivel Steel Anchor & Bolt Options**

PART NUMBER	DESCRIPTION
021-4047	5K Swivel Steel Anchor & Bolt
021-4062	5K Swivel Steel Anchor
021-4070	5K Swivel Anchor Bolt



**5K Swivel Stainless Steel Anchor & Bolt**  
**021-4046**

- 180° / 360° rotating connection point
- Corrosion-resistant stainless steel
- Installs quickly with 1/2" fastener
- Temporary or permanent
- Vertical or horizontal use
- Minimum Breaking Strength: 5,000 lbs.
- Weight Capacity ANSI 130-310 lbs., OSHA 420 lbs.
- ANSI Z359.18-2017 Type A, OSHA 1926.502, 1910.140, 1910.66

**5K Swivel Stainless Steel Anchor & Bolt Options**

PART NUMBER	DESCRIPTION
021-4046	5K Swivel Stainless Steel Anchor & Bolt
021-4045	5K Swivel Stainless Steel Anchor
021-4063	5K Stainless Steel Puck & Bolt







## RATCHET ANCHOR STRAP

### FS-EX400-15

The Ratchet Anchor Strap is designed for use around columns, posts or other rated structures. The anchor fits tightly and securely in place without slippage.

- Lightweight and portable
- Easy installation
- Ratcheting tensioner
- 2" durable webbing
- O-ring connection point
- Available in multiple lengths
- Minimum Breaking Strength: 5,000 lbs.
- Weight Capacity ANSI 130-310 lbs., OSHA 420 lbs.
- OSHA 1926.502, 1910.140, 1910.66

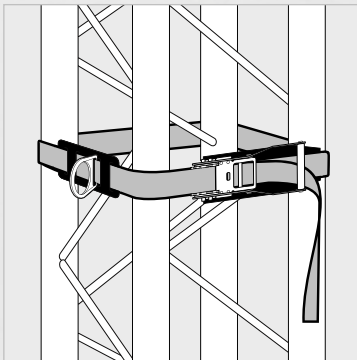

Durable Webbing



Ratcheting Tensioner



O-Ring Connection

#### Ratchet Anchor Strap Sizes

Part Number	Description	Length
FS-EX400-15	15' Ratchet Anchor Strap	15 ft.
FS-EX400-30	30' Ratchet Anchor Strap	30 ft.

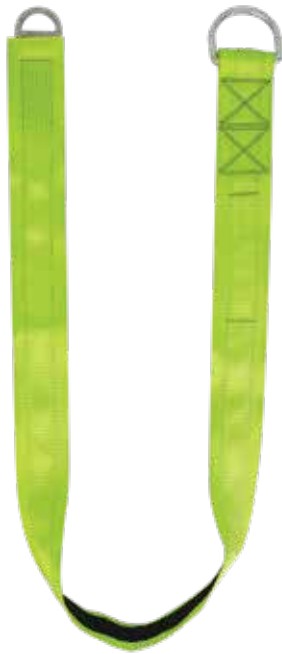

### Reinforced Cross Arm Strap

#### FS810-6

- Heavyweight strap webbing
- Abrasion resistant sling webbing wear pad
- Forged zinc-plated steel D-rings
- Lightweight and portable
- Minimum Breaking Strength: 5,000 lbs.
- Weight Capacity ANSI 130-310 lbs., OSHA 420 lbs.
- ANSI Z359.18-2017 Type T, OSHA 1926.502, 1910.140, 1910.66

#### Reinforced Cross Arm Strap Sizes

PART NUMBER	DESCRIPTION	LENGTH
FS810-3	3' Reinforced Cross-Arm Strap	3 ft.
FS810-6	6' Reinforced Cross-Arm Strap	6 ft.
FS810-10	10' Reinforced Cross-Arm Strap	10 ft.
FS810-15	15' Reinforced Cross-Arm Strap	15 ft.
FS810-20	20' Reinforced Cross-Arm Strap	20 ft.



### Cross Arm Strap

#### FS811-6

- Durable tubular strap webbing
- Zinc-plated steel D-rings
- Lightweight and portable
- Minimum Breaking Strength: 5,000 lbs.
- Weight Capacity ANSI 130-310 lbs., OSHA 420 lbs.
- ANSI Z359.18-2017 Type T, OSHA 1926.502, 1910.140, 1910.66

#### Cross Arm Strap Sizes

PART NUMBER	DESCRIPTION	LENGTH
FS811-3	3' Cross-Arm Strap	3 ft.
FS811-4	4' Cross-Arm Strap	4 ft.
FS811-6	6' Cross-Arm Strap	6 ft.
FS811-10	10' Cross-Arm Strap	10 ft.
FS811-15	15' Cross-Arm Strap	15 ft.
FS811-20	20' Cross-Arm Strap	20 ft.



### Adjustable Cross Arm Strap FS812

- Adjustable from 4' to 6'
- Durable strap webbing
- Zinc-plated steel D-rings
- Lightweight and portable
- Minimum Breaking Strength: 5,000 lbs.
- Weight Capacity ANSI 130-310 lbs., OSHA 420 lbs.
- OSHA 1926.502, 1910.140, 1910.66



### 6' Heavy Duty Cross Arm Strap FS88811-HW

- Heavyweight tubular strap webbing
- Zinc-plated steel D-rings
- Lightweight and portable
- Minimum Breaking Strength: 5,000 lbs.
- Weight Capacity ANSI 130-310 lbs., OSHA 420 lbs.
- ANSI Z359.18-2017 Type T, OSHA 1926.502, 1910.140, 1910.66



### Scaffold Anchor FS815

- Easily cinches around scaffolding
- Zinc-plated steel D-ring
- Durable 1" strap webbing
- Length: 18"
- Minimum Breaking Strength: 5,000 lbs.
- Weight Capacity ANSI 130-310 lbs., OSHA 420 lbs.
- OSHA 1926.502, 1910.140, 1910.66



### Cable Anchor FS830

- Thimble captive eye connection points
- Ideal for small-diameter situations
- Coated 5/16" galvanized steel cable
- Length: 24"
- Minimum Breaking Strength: 5,000 lbs.
- Weight Capacity ANSI 130-310 lbs., OSHA 420 lbs.
- ANSI Z359.18-2017 Type T, OSHA 1926.502, 1910.140, 1910.66



**Cable Choker Anchor  
FS830-C6**

- Forged pass-through steel O-rings
- Coated 5/16" galvanized steel cable
- Minimum Breaking Strength: 5,000 lbs.
- Weight Capacity ANSI 130-310 lbs., OSHA 420 lbs.
- ANSI Z359.18-2017 Type T, OSHA 1926.502, 1910.140, 1910.66

**Cable Choker Anchor Sizes**

PART NUMBER	DESCRIPTION	LENGTH
FS830-C3	3' Cable Choker Anchor	3 ft.
FS830-C6	6' Cable Choker Anchor	6 ft.
FS830-C8	8' Cable Choker Anchor	8 ft.
FS830-C10	10' Cable Choker Anchor	10 ft.



**6' Cable Choker Extender  
FS830-C6-1**

- Forged steel O-ring and snap hook
- Coated 5/16" galvanized steel cable
- Minimum Breaking Strength: 5,000 lbs.
- Weight Capacity ANSI 130-310 lbs., OSHA 420 lbs.
- ANSI Z359.18-2017 Type T, OSHA 1926.502, 1910.140, 1910.66

## STRUT ANCHOR

022-4089

The Strut Anchor has interlocking plates for installation so simple it can be done one-handed. Built-in red stripes warn of improper installation. Smooth sliding action allows user to work hands-free.

- Permanently attached plates for easy installation
- Compatible with with 1-5/8", 12 gauge or thicker strut channel
- For overhead use in pre-installed, closed strut
- Minimum Breaking Strength: 3,600 lbs.
- Weight Capacity ANSI 130-310 lbs., OSHA 420 lbs.
- OSHA 1926.502, 1910.140, 1910.66



Warning Stripes



Interlocking Plates



Smooth Sliding Action

## Reach Anchor

022-4086

- Proprietary system to remotely anchor to an elevated point
- Connects to I-beams, pipes and other anchor points
- Compact, lightweight and portable
- Remote release using telescoping pole and attachments
- Toggle prevents accidental disengagement
- Premium grade aluminum adds durability and strength
- Minimum Breaking Strength: 5,000 lbs.
- Maximum Install Height: 20' from working surface
- Weight Capacity ANSI 130-310 lbs., OSHA 420 lbs.
- ANSI Z359.18-2017 Type A, OSHA 1926.502, 1910.140, 1910.66





**Parapet Wall Anchor  
SW900**

- Non-penetrating rubber padded design eliminates wall damage
- [2] tightening handles for even force distribution
- High strength steel construction with built-in D-ring
- Accommodates 2.4"-14.1" concrete parapet wall thickness
- Minimum 8.6" parapet height installation
- Dimensions: 22" x 14"
- Minimum Breaking Strength: 5,000 lbs.
- Weight Capacity ANSI 130-310 lbs., OSHA 420 lbs.
- ANSI Z359.18-2017 Type A, OSHA 1926.502, 1910.140, 1910.66



**Window Door Jamb Anchor  
SW901**

- Lightweight aluminum construction
- Stainless steel connection point
- Eliminates structural damage
- Installs into jamb openings 23.2"-49.2"
- Portable and reusable with quick installation
- Length: 59.5" (151 mm)
- Minimum Breaking Strength: 5,000 lbs.
- Weight Capacity ANSI 130-310 lbs., OSHA 420 lbs.
- ANSI Z359.18-2017 Type A, OSHA 1926.502, 1910.140, 1910.66



**Drop-Through Cable Anchor  
020-4020**

- 8" high visibility green steel plate
- Forged steel swiveling connection point
- 1/4" steel cable with wear sleeve
- Accommodates openings from 1.75" to 6"
- Minimum Breaking Strength: 5,000 lbs.
- Weight Capacity ANSI 130-310 lbs., OSHA 420 lbs.
- OSHA 1926.502, 1910.140, 1910.66

**Drop Through Cable Anchor Sizes**

Part Number	Description	Length
020-4020	2' Drop-Through Anchor	2 ft.
020-4021	8.5' Drop-Through Anchor	8.5 ft.



### 10K Swivel Anchor & Back Plate 021-4043

- Versatile use on reinforced cinder block, chillers, metal or AC walls
- Includes 5/8" bolt and wingnut
- Maximum span up to 12"
- Plate Dimensions: 6" x 4" x 1/4"
- Minimum Breaking Strength: 10,000 lbs.
- Weight Capacity ANSI 130-310 lbs., OSHA 420 lbs.
- ANSI Z359.18-2017 Type A, OSHA 1926.502, 1910.140, 1910.66



### Stainless Steel Wire Clamp Anchor FS886

- Quick and easy to install, no tools required
- Spring located opening
- Fits rated structures up to 5" in diameter
- For overhead applications only
- Minimum Breaking Strength: 5,000 lbs.
- Weight Capacity ANSI 130-310 lbs., OSHA 420 lbs.
- OSHA 1926.502, 1910.140, 1910.66



**INTERESTED IN THE  
NEWEST RELEASES  
FOR ANCHORS?**

Scan this code to view them now!



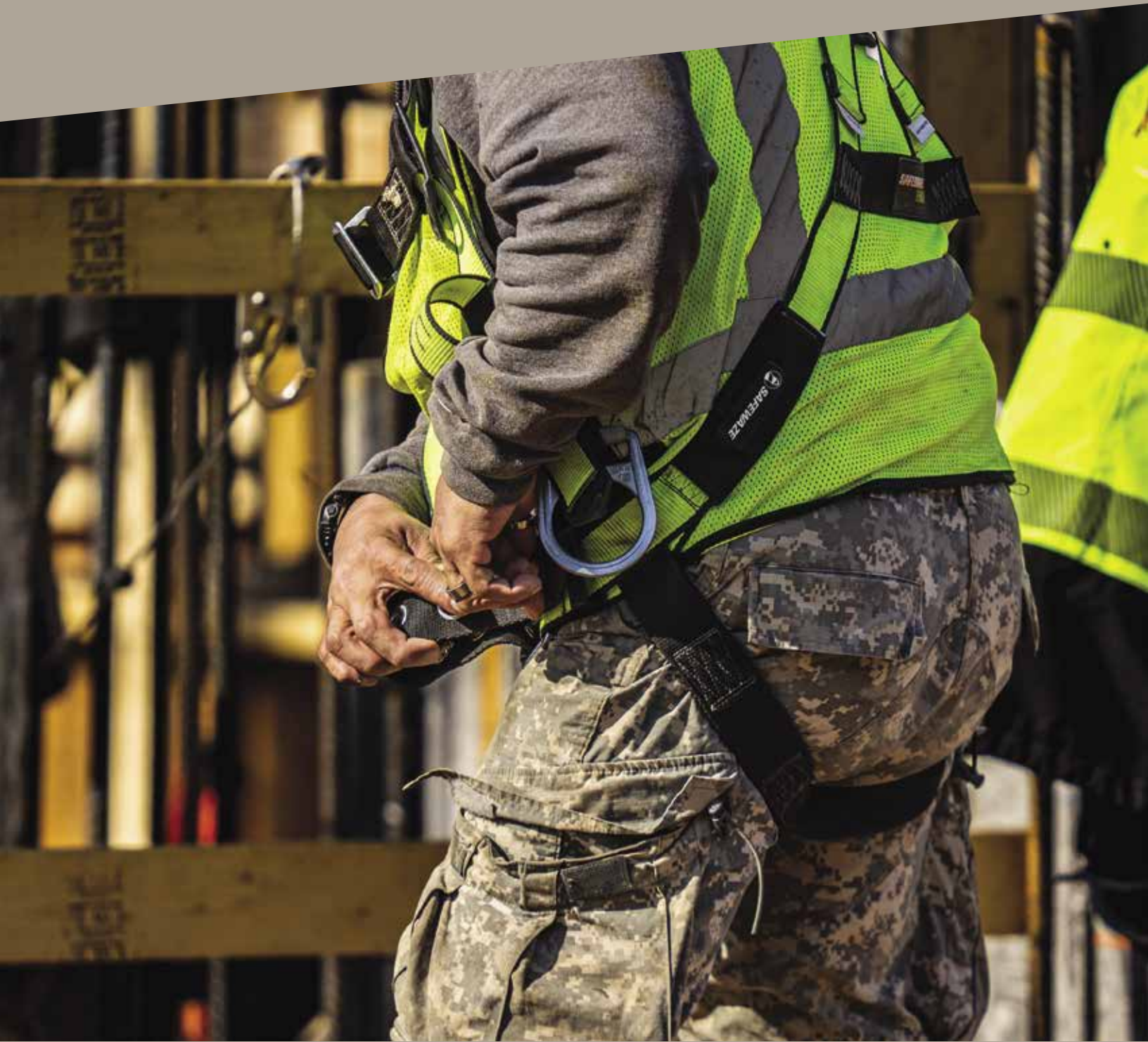

# HARNESSES

We know you've got a job to do. Your harness needs to provide all-day comfort and flexibility without getting in the way of productivity, in addition to keeping you safe in the event of a fall. Our comprehensive line includes a variety of configurations to provide a perfect fit for both you and the job at hand.





### PRO⊕ SLATE

Equipped with aluminum D-rings, moisture wicking breathable padding, effortless aluminum torso adjusters, durable webbing, quick-connect chest buckle and removable belt for tool bags. Offered in both belted and non-belted configuration.



### PRO⊕

Equipped with steel D-ring, moisture wicking breathable padding, effortless aluminum torso adjusters, durable high visibility webbing, quick-connect chest buckle and removable belt for tool bags. Offered in both belted and non-belted configuration.



### PRO

Features exclusive comfort pads for all day use, forged steel D-rings, abrasion resistant webbing, spring loaded torso adjusters and removable belt for tool bags. Offered in a wide variety of configurations.



### V-SELECT

Innovative and affordable including new breathable pads with moisture and bacteria resistance. Engineered with integrated SRL channel, easy-adjust webbing and corrosion resistant hardware. Offered with a consolidated size range.



### V-LINE

Built for diversity, this line offers padded and non-padded models, forged steel D-rings, pass-through chest and easily adjusted torso. Available in various configurations.



### ARC FLASH

Constructed with mill-spec nylon webbing or superior aramid fiber webbing for protection and durability in the most extreme environments. Soft loops and coated steel dielectric components available. Available in various configurations.



### WELDING

Designed for extreme environments and developed to be used by welders or workers that are exposed to flame, fire and other associated welding processes.



### HEAVYWEIGHT

Built for the big boys dealing with the toughest jobs with thicker stronger webbing and graded up to extra large sizes.



### SPECIALTY

Unique industry specific products built for a wide variety of applications including; Wind Energy/Tower Climbing, Oil & Gas and High Visibility.

1

**PRO+ SLATE  
CONSTRUCTION HARNESS:  
ALU 3D, ALU QC CHEST, ALU FD,  
TB LEGS**

020-1182

The PRO+ Slate Harness is the embodiment of dependable performance and superior comfort. High strength abrasion resistant webbing and advanced technical padding, composed of moisture wicking linings and closed cell foam, provide all-day ease of use and extended product life. Models equipped with an integrated SRL channel, lightweight aluminum D-rings, quick-connect buckles and torso adjusters.



- Dorsal and front D-rings
- Integrated SRL channel
- Side positioning D-rings
- Quick torso adjusters
- Quick-connect chest
- Tongue buckle legs
- Fixed shoulder and waist pads
- Removable leg pads
- Weight Capacity ANSI 130-310 lbs., OSHA 420 lbs.
- ANSI Z359.11-2021, OSHA 1926.502, 1910.140



Shoulder Pads



Quick-Connect Chest Buckle



Integrated SRL Channel



Torso Adjuster



Leg Pads



Waist Pad



2

**PRO+ Slate Construction Harness:**

Alu 3D, Alu QC Chest, Alu FD, Alu QC Legs

**021-1827**

- Dorsal and front D-rings
- Integrated SRL channel
- Side positioning D-rings
- Quick torso adjusters
- Quick-connect chest
- Quick-connect legs
- Fixed shoulder and waist pads
- Removable leg pads
- Weight Capacity ANSI 130-310 lbs., OSHA 420 lbs.
- ANSI Z359.11-2021, OSHA 1926.502, 1910.140



3

**PRO+ Slate Construction Harness:**

Alu 3D, Alu QC Chest, TB Legs

**020-1190**

- Dorsal D-ring
- Integrated SRL channel
- Side positioning D-rings
- Quick torso adjusters
- Quick-connect chest
- Tongue buckle legs
- Fixed shoulder and waist pads
- Removable leg pads
- Weight Capacity ANSI 130-310 lbs., OSHA 420 lbs.
- ANSI Z359.11-2021, OSHA 1926.502, 1910.140

**PRO+ Slate Harness Sizes**

	XSMALL	SMALL	MEDIUM	LARGE	XLARGE	2X	3X
1	020-1180	020-1181	020-1182	020-1183	020-1184	020-1185	020-1186
2	021-1825	021-1826	021-1827	021-1828	021-1829	021-1830	021-1831
3	020-1188	020-1189	020-1190	020-1191	020-1192	020-1193	020-1194



4

**PRO+ Slate Construction Harness:**  
Alu 3D, Alu QC Chest, TB Legs, Trauma Relief  
**023-1257**

- Dorsal D-ring
- Integrated SRL channel
- Side positioning D-rings
- Quick torso adjusters
- Quick-connect chest
- Tongue buckle legs
- Fixed shoulder and waist pads
- Removable leg pads
- Integrated Quick-Adjust Trauma Relief packs
- Weight Capacity ANSI 130-310 lbs., OSHA 420 lbs.
- ANSI Z359.11-2021, OSHA 1926.502, 1910.140



5

**PRO+ Slate Construction Harness:**  
Alu 3D, Alu QC Chest/Legs  
**021-1819**

- Dorsal D-ring
- Integrated SRL channel
- Side positioning D-rings
- Quick torso adjusters
- Quick-connect chest
- Quick-connect legs
- Fixed shoulder and waist pads
- Removable leg pads
- Weight Capacity ANSI 130-310 lbs., OSHA 420 lbs.
- ANSI Z359.11-2021, OSHA 1926.502, 1910.140



BUILT-IN TRAUMA RELIEF PACKS



6

**PRO+ Slate Construction Harness:**  
Alu 1D, Alu QC Chest, TB Legs  
**020-1198**

- Dorsal D-ring
- Integrated SRL channel
- Quick torso adjusters
- Quick-connect chest
- Tongue buckle legs
- Fixed shoulder and waist pads
- Removable leg pads
- Weight Capacity ANSI 130-310 lbs., OSHA 420 lbs.
- ANSI Z359.11-2021, OSHA 1926.502, 1910.140



7

**PRO+ Slate Full Body Harness:**  
Alu 3D, Alu QC Chest, TB Legs  
**020-1206**

- Dorsal D-ring
- Integrated SRL channel
- Side positioning D-rings
- Quick torso adjusters
- Quick-connect chest
- Tongue buckle legs
- Fixed shoulder pad
- Removable leg pads
- Weight Capacity ANSI 130-310 lbs., OSHA 420 lbs.
- ANSI Z359.11-2021, OSHA 1926.502, 1910.140



**8** **PRO+ Slate Full Body Retrieval Harness:** Alu 1D, Alu Shoulder D's, Alu QC Chest, Alu FD, TB Legs  
**022-1951**

- Dorsal and front D-rings
- Shoulder retrieval D-rings
- Integrated SRL channel
- Quick torso adjusters
- Quick-connect chest
- Tongue buckle legs
- Fixed shoulder pad
- Removable leg pads
- Weight Capacity ANSI 130-310 lbs., OSHA 420 lbs.
- ANSI Z359.11-2021, OSHA 1926.502, 1910.140



**9** **PRO+ Slate Full Body Harness:** Alu 1D, Alu QC Chest, Alu FD, TB Legs  
**020-1214**

- Dorsal and front D-rings
- Integrated SRL channel
- Quick torso adjusters
- Quick-connect chest
- Tongue buckle legs
- Fixed shoulder pad
- Removable leg pads
- Weight Capacity ANSI 130-310 lbs., OSHA 420 lbs.
- ANSI Z359.11-2021, OSHA 1926.502, 1910.140

**PRO+ Slate Harness Sizes**

	XSMALL	SMALL	MEDIUM	LARGE	XLARGE	2X	3X	4X
4	023-1255	023-1256	023-1257	023-1258	023-1259	023-1260	023-1261	023-1262
5	021-1817	021-1818	021-1819	021-1820	021-1821	021-1822	021-1823	—
6	020-1196	020-1197	020-1198	020-1199	020-1200	020-1201	020-1202	—
7	020-1204	020-1205	020-1206	020-1207	020-1208	020-1209	020-1210	—
8	—	022-1950	022-1951	022-1952	022-1953	022-1954	022-1955	—
9	020-1212	020-1213	020-1214	020-1215	020-1216	020-1217	020-1218	—



**10** **PRO+ Slate Full Body Harness:**  
Alu 1D, Alu QC Chest/  
Legs  
**020-1222**

- Dorsal D-ring
- Integrated SRL channel
- Quick torso adjusters
- Quick-connect chest
- Quick-connect legs
- Fixed shoulder pad
- Removable leg pads
- Weight Capacity ANSI 130-310 lbs., OSHA 420 lbs.
- ANSI Z359.11-2021, OSHA 1926.502, 1910.140



**11** **PRO+ Slate Full Body Harness:**  
Alu 1D, Alu QC Chest/  
Legs, Trauma Relief  
**023-1265**

- Dorsal D-ring
- Integrated SRL channel
- Quick torso adjusters
- Quick-connect chest
- Quick-connect legs
- Fixed shoulder pad
- Removable leg pads
- Integrated Quick-Adjust Trauma Relief packs
- Weight Capacity ANSI 130-310 lbs., OSHA 420 lbs.
- ANSI Z359.11-2021, OSHA 1926.502, 1910.140



BUILT-IN TRAUMA RELIEF PACKS



**12** **PRO+ Full Body Harness:**  
Alu 1D, Alu QC Chest,  
TB Legs  
**020-1230**

- Dorsal D-ring
- Integrated SRL channel
- Quick torso adjusters
- Quick-connect chest
- Tongue buckle legs
- Fixed shoulder pad
- Removable leg pads
- Weight Capacity ANSI 130-310 lbs., OSHA 420 lbs.
- ANSI Z359.11-2021, OSHA 1926.502, 1910.140

**DEBUNKING**  
THE 5 YEAR INSPECTION MYTH

Daily inspection by the user as well as documented inspection by a competent person determines how long a product can stay in service. There is a myth in the industry that your fall protection equipment “expires” after 5 years, but a properly cared for and inspected piece of equipment can provide years of protection. Likewise, a mishandled product could have a very short life span.

**PRO+ Slate Harness Sizes**

	XSMALL	SMALL	MEDIUM	LARGE	XLARGE	2X	3X	4X
10	020-1220	020-1221	020-1222	020-1223	020-1224	020-1225	020-1226	—
11	023-1263	023-1264	023-1265	023-1266	023-1267	023-1268	023-1269	023-1270
12	020-1228	020-1229	020-1230	020-1231	020-1232	020-1233	020-1234	—

# SAFEWAZE PRODUCT SIZING

	XS	S	M	L	XL	2X	3X											
HEIGHT - FT./IN. (M)																		
6'10" (2.08)						3X												
6'8" (2.03)						2X												
6'6" (1.98)					XL													
6'4" (1.93)				L														
6'2" (1.88)			M															
6' (1.83)		S																
5'10" (1.78)																		
5'8" (1.68)	XS																	
5'6" (1.68)																		
5'4" (1.63)																		
5'2" (1.85)																		
5' (1.52)																		
4'10" (1.47)																		
	80 (36)	100 (45)	120 (54)	140 (63)	160 (73)	180 (82)	200 (91)	220 (100)	240 (109)	260 (118)	280 (127)	300 (136)	320 (145)	340 (154)	360 (163)	380 (172)	400 (181)	420 (190)
	WEIGHT - LBS. (KG)																	

Use our sizing guide to find the right size and style of fall protection harness. Proper harness fit is critical for job safety and in the event of a fall.

### BELT SIZING

SIZE	MEASUREMENT
XS	24" - 33"
S	26" - 32"
M	32" - 36"
L	36" - 40"
XL	40" - 46"
2X	46" - 52"
3X	52" - ABOVE





1

**PRO+**  
**CONSTRUCTION HARNESS:**  
**3D, QC CHEST, TB LEGS**

FS-FLEX360

The PRO+ Harness is our all-steel premium harness, combining innovation with functionality. Hi-vis abrasion resistant green webbing and advanced technical padding, composed of moisture wicking linings and closed cell foam, provide all-day ease of use and extended product life. Models equipped with integrated SRL channel, corrosive resistant steel-plated D-rings, quick-connect buckles and aluminum torso adjusters.

- Dorsal D-ring
- Integrated SRL channel
- Side positioning D-rings
- Quick torso adjusters
- Quick-connect chest
- Tongue buckle legs
- Fixed shoulder pad
- Floating waist pad
- Removable leg pads
- Weight Capacity ANSI 130-310 lbs., OSHA 420 lbs.
- ANSI Z359.11-2021, OSHA 1926.502, 1910.140



Side D-Ring



Quick-Connect Chest Buckle



Integrated SRL Channel



Shoulder Pad



Torso Adjuster



Waist Pad

Construction Harness Option: 1D

2	Part Number	Description
	021-1435	PRO+ Construction Harness: 1D, QC Chest, TB Legs





3

**PRO+ Construction Harness: 3D, QC Chest, TB Legs, Trauma Relief 023-1243**

- Dorsal D-ring
- Integrated SRL channel
- Side positioning D-rings
- Quick torso adjusters
- Quick-connect chest
- Tongue buckle legs
- Fixed shoulder pad
- Floating waist pad
- Removable leg pads
- Integrated Quick-Adjust Trauma Relief packs
- Weight Capacity ANSI 130-310 lbs., OSHA 420 lbs.
- ANSI Z359.11-2021, OSHA 1926.502, 1910.140



BUILT-IN TRAUMA RELIEF PACKS



4

**PRO+ Construction Harness: 3D, QC Chest, TB Legs, TB Torso FS-FLEX270**

**FS-FLEX270**

- Fixed dorsal D-ring
- Integrated SRL channel
- Side positioning D-rings
- Iron worker tongue buckle torso adjustment
- Quick-connect chest
- Tongue buckle legs
- Reinforced shoulder pad
- Fixed waist pad
- Removable leg pads
- Weight Capacity ANSI 130-310 lbs., OSHA 420 lbs.
- ANSI Z359.11-2021, OSHA 1926.502, 1910.140

**PRO+ Harness Sizes**

	XSMALL	SMALL	MEDIUM	LARGE	XLARGE	2X	3X	4X
1	FS-FLEX360-XS	FS-FLEX360-S	FS-FLEX360-M	FS-FLEX360-L	FS-FLEX360-XL	FS-FLEX360-2X	FS-FLEX360-3X	—
2	021-1433	021-1434	021-1435	021-1436	021-1437	021-1438	021-1439	—
3	023-1241	023-1242	023-1243	023-1244	023-1245	023-1246	023-1247	023-1248
4	FS-FLEX270-XS	FS-FLEX270-S	FS-FLEX270-M	FS-FLEX270-L	FS-FLEX270-XL	FS-FLEX270-2X	FS-FLEX270-3X	FS-FLEX270-4X



5

**PRO+ Full Body Harness:**  
3D, QC Chest/Legs  
**FS-FLEX285-QC**

- Dorsal D-ring
- Integrated SRL channel
- Side positioning D-rings
- Quick torso adjusters
- Quick-connect chest
- Quick-connect legs
- Fixed shoulder pad
- Removable leg pads
- Weight Capacity ANSI 130-310 lbs., OSHA 420 lbs.
- ANSI Z359.11-2021, OSHA 1926.502, 1910.140



6

**PRO+ Full Body Harness:**  
3D, QC Chest, TB Legs  
**FS-FLEX285**

- Dorsal D-ring
- Integrated SRL channel
- Side positioning D-rings
- Quick torso adjusters
- Quick-connect chest
- Tongue buckle legs
- Fixed shoulder pad
- Removable leg pads
- Weight Capacity ANSI 130-310 lbs., OSHA 420 lbs.
- ANSI Z359.11-2021, OSHA 1926.502, 1910.140



7

**PRO+ Full Body Harness:**  
1D, QC Chest, FD, QC Legs  
**FS-FLEX280-FD**

- Dorsal and front D-rings
- Integrated SRL channel
- Quick torso adjusters
- Quick-connect chest
- Quick-connect legs
- Fixed shoulder pad
- Removable leg pads
- Weight Capacity ANSI 130-310 lbs., OSHA 420 lbs.
- ANSI Z359.11-2021, OSHA 1926.502, 1910.140



8

**PRO+ Full Body Harness:**  
1D, QC Chest/Legs  
**FS-FLEX280**

- Dorsal D-ring
- Integrated SRL channel
- Quick torso adjusters
- Quick-connect chest
- Quick-connect legs
- Fixed shoulder pad
- Removable leg pads
- Weight Capacity ANSI 130-310 lbs., OSHA 420 lbs.
- ANSI Z359.11-2021, OSHA 1926.502, 1910.140

**PRO+ Harness Sizes**

	XSMALL	SMALL/MEDIUM	LARGE/XLARGE	2X	3X
5	FS-FLEX285-QC-XS	FS-FLEX285-QC-S/M	FS-FLEX285-QC-L/XL	FS-FLEX285-QC-2X	FS-FLEX285-QC-3X
6	FS-FLEX285-XS	FS-FLEX285-S/M	FS-FLEX285-L/XL	FS-FLEX285-2X	FS-FLEX285-3X
7	FS-FLEX280-FD-XS	FS-FLEX280-FD-S/M	FS-FLEX280-FD-L/XL	FS-FLEX280-FD-2X	FS-FLEX280-FD-3X
8	FS-FLEX280-XS	FS-FLEX280-S/M	FS-FLEX280-L/XL	FS-FLEX280-2X	FS-FLEX280-3X



**9 PRO+ Full Body Harness:**  
1D, QC Chest, TB Legs  
**FS-FLEX185**

- Dorsal D-ring
- Integrated SRL channel
- Quick torso adjusters
- Quick-connect chest
- Tongue buckle legs
- Fixed shoulder pad
- Removable leg pads
- Weight Capacity ANSI 130-310 lbs., OSHA 420 lbs.
- ANSI Z359.11-2021, OSHA 1926.502, 1910.140



**10 PRO+ Full Body Harness:**  
1D, QC Chest, TB Legs, Trauma Relief  
**023-1250**

- Dorsal D-ring
- Integrated SRL channel
- Quick torso adjusters
- Quick-connect chest
- Tongue buckle legs
- Fixed shoulder pad
- Removable leg pads
- Integrated Quick-Adjust Trauma Relief packs
- Weight Capacity ANSI 130-310 lbs., OSHA 420 lbs.
- ANSI Z359.11-2021, OSHA 1926.502, 1910.140



**PRO+ Harness Sizes**

	XSMALL	SMALL/MEDIUM	LARGE/XLARGE	2X	3X	4X
9	FS-FLEX185-XS	FS-FLEX185-S/M	FS-FLEX185-L/XL	FS-FLEX185-2X	FS-FLEX185-3X	—
10	023-1249	023-1250	023-1251	023-1252	023-1253	023-1254

**FULL-BODY HARNESS FITTING**

A harness that is too loose may not protect you in a fall and can present a choking hazard. A harness that is too tight is uncomfortable and can cause injury such as muscle strains or a pinched nerve. Not only does the harness need proper sizing for your body, it requires proper adjustment on your body. Follow the steps below with a correctly sized harness to ensure the correct fit.



**1** Pull leg straps between legs and connect to opposite ends. For a belted harness, connect waist strap after leg straps.

Use two buckles at base of shoulder straps to adjust shoulder straps. Position extra seat strap below seat of pants.

**2** Fasten chest strap across chest. Chest strap should be comfortably snug.

Chest strap should NOT be close to user's neck, as strap may contact neck if back D-ring slides up during fall arrest. The chest strap should sit right where your rib cage splits.

**3** After all straps are buckled, tighten all buckles so that harness fits snug and allows full range of movement.

Secure excess strap in strap keepers.

1

**PRO**

**CONSTRUCTION HARNESS: 3D, QC CHEST, TB LEGS**

FS170-QC

The PRO Harness is a dependable workhorse, incorporating premium features for outstanding performance. Built with ergonomically designed padding and hi-vis abrasion-resistant green webbing. Models equipped with corrosive resistant steel-plated D-rings, buckles and quick-connects.

- Dorsal D-ring
- Integrated SRL channel
- Side positioning D-rings
- Friction buckle torso adjusters
- Quick-connect chest
- Tongue buckle legs
- Fixed shoulder and waist pads
- Weight Capacity ANSI 130-310 lbs., OSHA 420 lbs.
- ANSI Z359.11-2021, OSHA 1926.502, 1910.140



Tongue Buckle Leg



Side D-Ring

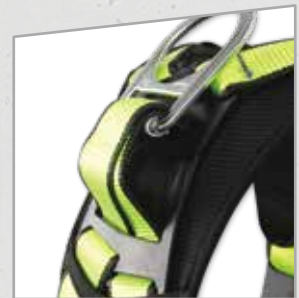

Integrated SRL Channel



Torso Adjuster



Lanyard Keeper



Waist Pad

**Construction Harness Option: MB Chest**

2

Part Number	Description
FS170	PRO Construction Harness: 3D, MB Chest, TB Legs



**3** PRO Construction Harness:  
3D, MB Chest, TB Legs, Trauma Relief  
**023-1229**

- Dorsal D-ring
- Integrated SRL channel
- Side positioning D-rings
- Friction buckle torso adjusters
- Mating buckle chest
- Tongue buckle legs
- Fixed shoulder and waist pads
- Integrated Quick-Adjust Trauma Relief packs
- Weight Capacity ANSI 130-310 lbs., OSHA 420 lbs.
- ANSI Z359.11-2021, OSHA 1926.502, 1910.140



BUILT-IN TRAUMA RELIEF PACKS



**4** PRO Construction Harness:  
1D, QC Chest, TB Legs  
**021-1443**

- Dorsal D-ring
- Integrated SRL channel
- Friction buckle torso adjusters
- Quick-connect chest
- Tongue buckle legs
- Fixed shoulder and waist pads
- Weight Capacity ANSI 130-310 lbs., OSHA 420 lbs.
- ANSI Z359.11-2021, OSHA 1926.502, 1910.140



**5** PRO Construction Harness:  
3D, QC Chest/Legs  
**021-1451**

- Dorsal D-ring
- Integrated SRL channel
- Side positioning D-rings
- Friction buckle torso adjusters
- Quick-connect chest
- Quick-connect legs
- Fixed shoulder pad
- Floating waist pad
- Weight Capacity ANSI 130-310 lbs., OSHA 420 lbs.
- ANSI Z359.11-2021, OSHA 1926.502, 1910.140



**6** PRO Construction Harness:  
3D, MB Chest, TB Legs  
**FS160**

- Dorsal D-ring
- Integrated SRL channel
- Side positioning D-rings
- Friction buckle torso adjusters
- Mating buckle chest
- Tongue buckle legs
- Fixed shoulder pad
- Floating waist pad
- Weight Capacity ANSI 130-310 lbs., OSHA 420 lbs.
- ANSI Z359.11-2021, OSHA 1926.502, 1910.140

**PRO Harness Sizes**

	XSMALL	SMALL	MEDIUM	LARGE	XLARGE	2X	3X	4X
1	FS170-QC-XS	FS170-QC-S	FS170-QC-M	FS170-QC-L	FS170-QC-XL	FS170-QC-2X	FS170-QC-3X	—
2	FS170-XS	FS170-S	FS170-M	FS170-L	FS170-XL	FS170-2X	FS170-3X	—
3	023-1227	023-1228	023-1229	023-1230	023-1231	023-1232	023-1233	023-1234
4	021-1441	021-1442	021-1443	021-1444	021-1445	021-1446	021-1447	—
5	021-1449	021-1450	021-1451	021-1452	021-1453	021-1454	021-1455	—
6	FS160-XS	FS160-S	FS160-M	FS160-L	FS160-XL	FS160-2X	FS160-3X	—



**7** **PRO Full Body Harness:**  
3D, MB Chest, FD, TB Legs  
**019-1063**

- Dorsal and front D-rings
- Integrated SRL channel
- Side positioning D-rings
- Friction buckle torso adjusters
- Mating buckle chest
- Tongue buckle legs
- Fixed shoulder pad
- Weight Capacity ANSI 130-310 lbs., OSHA 420 lbs.
- ANSI Z359.11-2021, OSHA 1926.502, 1910.140



**8** **PRO Full Body Harness:**  
3D, QC Chest, TB Legs  
**FS285-QC**

- Dorsal D-ring
- Integrated SRL channel
- Side positioning D-rings
- Friction buckle torso adjusters
- Quick-connect chest
- Tongue buckle legs
- Fixed shoulder pad
- Weight Capacity ANSI 130-310 lbs., OSHA 420 lbs.
- ANSI Z359.11-2021, OSHA 1926.502, 1910.140



**9** **PRO Full Body Harness:**  
3D, MB Chest, TB Legs  
**FS285**

- Dorsal D-ring
- Integrated SRL channel
- Side positioning D-rings
- Friction buckle torso adjusters
- Mating buckle chest
- Tongue buckle legs
- Fixed shoulder pad
- Weight Capacity ANSI 130-310 lbs., OSHA 420 lbs.
- ANSI Z359.11-2021, OSHA 1926.502, 1910.140



**10** **PRO Full Body Harness:**  
3D, MB Chest/Legs  
**FS281**

- Dorsal D-ring
- Integrated SRL channel
- Side positioning D-rings
- Friction buckle torso adjusters
- Mating buckle chest
- Mating buckle legs
- Fixed shoulder pad
- Weight Capacity ANSI 130-310 lbs., OSHA 420 lbs.
- ANSI Z359.11-2021, OSHA 1926.502, 1910.140

**PRO Harness Sizes**

	XSMALL	SMALL/MEDIUM	LARGE/XLARGE	2X	3X
7	019-1066	019-1063	019-1064	019-1065	—
8	FS285-QC-XS	FS285-QC-S/M	FS285-QC-L/XL	FS285-QC-2X	FS285-QC-3X
9	FS285-XS	FS285-S/M	FS285-L/XL	FS285-2X	FS285-3X
10	FS281-XS	FS281-S/M	FS281-L/XL	FS281-2X	FS281-3X



11

**PRO Full Body Harness:**  
1D, QC Chest/Legs  
**SW280-QC**

- Dorsal D-ring
- Integrated SRL channel
- Friction buckle torso adjusters
- Quick-connect chest
- Quick-connect legs
- Fixed shoulder pad
- Weight Capacity ANSI 130-310 lbs., OSHA 420 lbs.
- ANSI Z359.11-2021, OSHA 1926.502, 1910.140



12

**PRO Full Body Harness:**  
1D, QC Chest, TB Legs  
**FS185-QC**

- Dorsal D-ring
- Integrated SRL channel
- Friction buckle torso adjusters
- Quick-connect chest
- Tongue buckle legs
- Fixed shoulder pad
- Weight Capacity ANSI 130-310 lbs., OSHA 420 lbs.
- ANSI Z359.11-2021, OSHA 1926.502, 1910.140



13

**PRO Full Body Retrieval Harness:**  
1D, Shoulder D, MB Chest, TB Legs  
**FS185-R**

- Dorsal D-ring
- Integrated SRL channel
- Friction buckle torso adjusters
- Mating buckle chest
- Shoulder D-rings
- Tongue buckle legs
- Fixed shoulder pad
- Weight Capacity ANSI 130-310 lbs., OSHA 420 lbs.
- ANSI Z359.11-2021, OSHA 1926.502, 1910.140



14

**PRO Full Body Harness:**  
1D, MB Chest, FD, TB Legs  
**FS185-FD**

- Dorsal and front D-rings
- Integrated SRL channel
- Friction buckle torso adjusters
- Mating buckle chest
- Tongue buckle legs
- Fixed shoulder pad
- Weight Capacity ANSI 130-310 lbs., OSHA 420 lbs.
- ANSI Z359.11-2021, OSHA 1926.502, 1910.140

**PRO Harness Sizes**

	XSMALL	SMALL/MEDIUM	LARGE/XLARGE	2X	3X
11	SW280-QC-XS	SW280-QC-S/M	SW280-QC-L/XL	SW280-QC-2X	SW280-QC-3X
12	FS185-QC-XS	FS185-QC-S/M	FS185-QC-L/XL	FS185-QC-2X	FS185-QC-3X
13	FS185-R-XS	FS185-R-S/M	FS185-R-L/XL	FS185-R-2X	FS185-R-3X
14	FS185-FD-XS	FS185-FD-S/M	FS185-FD-L/XL	FS185-FD-2X	FS185-FD-3X



**15** **PRO Full Body Harness:**  
1D, MB Chest, TB Legs  
**FS185**

- Dorsal D-ring
- Integrated SRL channel
- Friction buckle torso adjusters
- Mating buckle chest
- Tongue buckle legs
- Fixed shoulder pad
- Weight Capacity ANSI 130-310 lbs., OSHA 420 lbs.
- ANSI Z359.11-2021, OSHA 1926.502, 1910.140

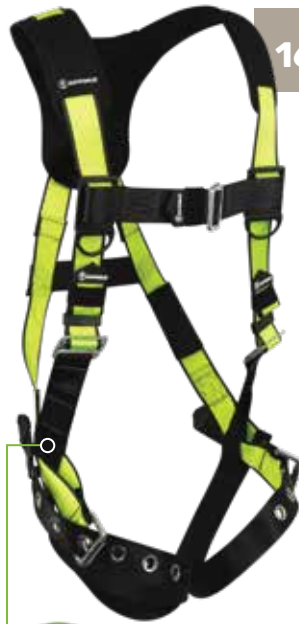

**16** **PRO Full Body Harness:**  
1D, MB Chest, TB Legs, Trauma Relief  
**023-1236**

- Dorsal D-ring
- Integrated SRL channel
- Friction buckle torso adjusters
- Mating buckle chest
- Tongue buckle legs
- Fixed shoulder pad
- Integrated Quick-Adjust Trauma Relief packs
- Weight Capacity ANSI 130-310 lbs., OSHA 420 lbs.
- ANSI Z359.11-2021, OSHA 1926.502, 1910.140



BUILT-IN TRAUMA RELIEF PACKS



**17** **PRO Full Body Harness:**  
1D, MB Chest/Legs  
**FS280**

- Dorsal D-ring
- Integrated SRL channel
- Friction buckle torso adjusters
- Mating buckle chest
- Mating buckle legs
- Fixed shoulder pad
- Weight Capacity ANSI 130-310 lbs., OSHA 420 lbs.
- ANSI Z359.11-2021, OSHA 1926.502, 1910.140

**PRO Harness Sizes**

	XSMALL	SMALL/MEDIUM	LARGE/XLARGE	2X	3X	4X
15	FS185-XS	FS185-S/M	FS185-L/XL	FS185-2X	FS185-3X	—
16	023-1235	023-1236	023-1237	023-1238	023-1239	023-1240
17	FS280-XS	FS280-S/M	FS280-L/XL	FS280-2X	FS280-3X	—



## HARNESS INSPECTION GUIDE

Fall protection harnesses should be inspected visually and tactilely before each use and annually by a competent person. Grasp the webbing with your hands and bend, checking both sides. This creates surface tension making damage easier to see. Webbing or other damage may not show up through a sight (visual) inspection only.

### WEBBING DEFECTS

**FRAYED**



**CUT**

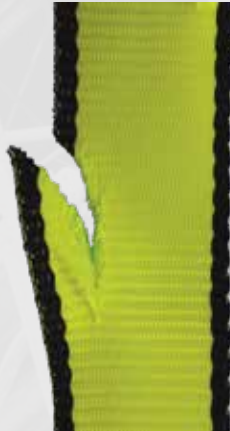

**BURNED**

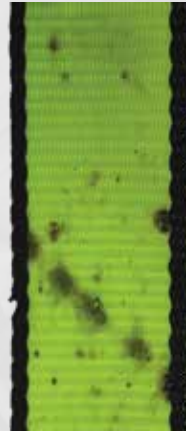

**SOILED**



### HARNESS DEFECT CHECKLIST

#### **WEBBING**

- Excessive hardness or brittleness
- Missing straps
- Broken fibers/cracks
- Overall deterioration
- Hard or shiny spots
- Mildew (clean harness)
- Modifications by user
- Discoloration of material (depending on cause)
- Cuts, nicks or tears
- Fraying/abrasions
- Burnt, charred or melted fibers

#### **LABELING:**

- Check labels
- If labeling is missing or illegible, remove harness from service.

#### **HARDWARE**

- Distortion (twists, bends)
- Rust or corrosion
- Broken/distorted grommets
- Modification by users (i.e. additional holes)
- Tongue buckle, mating buckle, and quick-connect should all function properly
- All adjuster springs must be in working condition

#### **STITCHING**

- Pulled stitches
- Stitching that is missing
- Fall indicators
- Hard or shiny spots
- Cut stitches
- Discoloration of stitching

#### **CLEANING AND STORAGE**

- Wipe off all surface dirt with a damp sponge using a mild solution of water and mild detergent. Work up a thick lather, with a vigorous back and forth motion. Rinse with fresh water then wipe dry with a clean cloth.
- Hang freely to dry, but away from excessive heat, steam or long periods of sunlight.
- Storage areas should be clean, dry and free of exposure to fumes, heat, direct ultraviolet light, sunlight and corrosive elements.
- Do not store harnesses near batteries or other chemicals.



**WARNING: NEVER ALTER YOUR HARNESS**

1

**V-SELECT  
CONSTRUCTION HARNESS:  
3D, QC CHEST, FD, TB LEGS**

021-1715

The V-Select Harness is an innovative and affordable option with exclusive features. Fixed pads are breathable, durable and bacteria resistant. Built with specially engineered easy-adjust webbing, integrated SRL channel, corrosion resistant steel hardware, breakaway lanyard keepers and protective label cover with size indicator. Lightweight line offered with consolidated sizes for convenience.

- Dorsal and front D-rings
- Integrated SRL channel
- Side positioning D-rings
- Friction buckle torso adjusters
- Quick-connect chest
- Tongue buckle legs
- Breakaway lanyard keepers
- Fixed shoulder and waist pads
- Weight Capacity ANSI 130-310 lbs., OSHA 420 lbs.
- ANSI Z359.11-2021, OSHA 1926.502, 1910.140



Torso Adjuster



Breathable Pads



Breakaway Keeper



Side D-Ring



Integrated SRL Channel



Waist Pad



**2** **V-Select Construction Harness:**  
3D, QC Chest/Legs  
**021-1721**

- Dorsal D-ring
- Integrated SRL channel
- Side positioning D-rings
- Friction buckle torso adjusters
- Quick-connect chest
- Quick-connect legs
- Breakaway lanyard keepers
- Fixed shoulder and waist pads
- Weight Capacity ANSI 130-310 lbs., OSHA 420 lbs.
- ANSI Z359.11-2021, OSHA 1926.502, 1910.140



**3** **V-Select Construction Harness:**  
3D, QC Chest, TB Legs  
**021-1727**

- Dorsal D-ring
- Integrated SRL channel
- Side positioning D-rings
- Friction buckle torso adjusters
- Quick-connect chest
- Tongue buckle legs
- Breakaway lanyard keepers
- Fixed shoulder and waist pads
- Weight Capacity ANSI 130-310 lbs., OSHA 420 lbs.
- ANSI Z359.11-2021, OSHA 1926.502, 1910.140

**V-Select Harness Sizes**

	XSMALL/SMALL	MEDIUM/LARGE	XLARGE/2X	3X
1	021-1714	021-1715	021-1716	021-1717
2	021-1720	021-1721	021-1722	021-1723
3	021-1726	021-1727	021-1728	021-1729



**4** **V-Select Construction Harness:**  
1D, QC Chest, TB Legs  
**021-1739**

- Dorsal D-ring
- Integrated SRL channel
- Friction buckle torso adjusters
- Quick-connect chest
- Tongue buckle legs
- Breakaway lanyard keepers
- Fixed shoulder and waist pads
- Weight Capacity ANSI 130-310 lbs., OSHA 420 lbs.
- ANSI Z359.11-2021, OSHA 1926.502, 1910.140



**5** **V-Select Full Body Harness:**  
3D, QC Chest, FD, TB Legs  
**021-1745**

- Dorsal and front D-rings
- Integrated SRL channel
- Side positioning D-rings
- Friction buckle torso adjusters
- Quick-connect chest
- Tongue buckle legs
- Breakaway lanyard keepers
- Fixed shoulder pad
- Weight Capacity ANSI 130-310 lbs., OSHA 420 lbs.
- ANSI Z359.11-2021, OSHA 1926.502, 1910.140



**6** **V-Select Full Body Harness:**  
3D, QC Chest/Legs  
**021-1751**

- Dorsal D-ring
- Integrated SRL channel
- Side positioning D-rings
- Friction buckle torso adjusters
- Quick-connect chest
- Quick-connect legs
- Breakaway lanyard keepers
- Fixed shoulder pad
- Weight Capacity ANSI 130-310 lbs., OSHA 420 lbs.
- ANSI Z359.11-2021, OSHA 1926.502, 1910.140



**7** **V-Select Full Body Harness:**  
1D, QC Chest/Legs  
**021-1769**

- Dorsal D-ring
- Integrated SRL channel
- Friction buckle torso adjusters
- Quick-connect chest
- Quick-connect legs
- Breakaway lanyard keepers
- Fixed shoulder pad
- Weight Capacity ANSI 130-310 lbs., OSHA 420 lbs.
- ANSI Z359.11-2021, OSHA 1926.502, 1910.140

**V-Select Harness Sizes**

	XSMALL/SMALL	MEDIUM/LARGE	XLARGE/2X	3X
4	021-1738	021-1739	021-1740	021-1741
5	021-1744	021-1745	021-1746	021-1747
6	021-1750	021-1751	021-1752	021-1753
7	021-1768	021-1769	021-1770	021-1771



**8** **V-Select Full Body Harness:**  
1D, QC Chest, TB Legs  
**022-1080**

- Dorsal D-ring
- Integrated SRL channel
- Friction buckle torso adjusters
- Quick-connect chest
- Tongue buckle legs
- Breakaway lanyard keepers
- Fixed shoulder pad
- Weight Capacity ANSI 130-310 lbs., OSHA 420 lbs.
- ANSI Z359.11-2021, OSHA 1926.502, 1910.140



**9** **V-Select Full Body Harness:**  
1D, MB Chest, TB Legs  
**021-1775**

- Dorsal D-ring
- Integrated SRL channel
- Friction buckle torso adjusters
- Mating buckle chest
- Tongue buckle legs
- Breakaway lanyard keepers
- Fixed shoulder pad
- Weight Capacity ANSI 130-310 lbs., OSHA 420 lbs.
- ANSI Z359.11-2021, OSHA 1926.502, 1910.140

**V-Select Harness Sizes**

	XSMALL/SMALL	MEDIUM/LARGE	XLARGE/2X	3X
8	022-1079	022-1080	022-1081	022-1082
9	021-1774	021-1775	021-1776	021-1777



1

**V-LINE**  
**CONSTRUCTION HARNESS:**  
**3D, MB CHEST, FD, TB LEGS**  
 FS99160-EFD

The V-Line Harness is our original dynamic solution for essential fall protection needs. Built for diversity, this lightweight, streamlined design optimizes mobility and comfort with both padded and non-padded models.

- Dorsal and front D-rings
- Side positioning D-rings
- Friction buckle torso adjusters
- Mating buckle chest
- Tongue buckle legs
- Shoulder pad
- Floating waist pad
- Weight Capacity ANSI 130-310 lbs., OSHA 420 lbs.
- ANSI Z359.11-2021, OSHA 1926.502, 1910.140



Webbing



Torso Adjuster



Front D-Ring



Side D-Ring



Lanyard Keeper



Waist Pad



**2** V-Line Construction Harness:  
3D, QC Chest/Legs  
**FS99160-E-QC**

- Dorsal D-ring
- Side positioning D-rings
- Friction buckle torso adjusters
- Quick-connect chest
- Quick-connect legs
- Shoulder pads
- Floating waist pad
- Weight Capacity ANSI 130-310 lbs., OSHA 420 lbs.
- ANSI Z359.11-2021, OSHA 1926.502, 1910.140



**3** V-Line Construction Harness:  
3D, QC Chest, TB Legs  
**021-1618**

- Dorsal D-ring
- Side positioning D-rings
- Friction buckle torso adjusters
- Quick-connect chest
- Tongue buckle legs
- Shoulder pads
- Floating waist pad
- Weight Capacity ANSI 130-310 lbs., OSHA 420 lbs.
- ANSI Z359.11-2021, OSHA 1926.502, 1910.140



**4** V-Line Construction Harness:  
3D, MB Chest, TB Legs  
**FS99160-E**

- Dorsal D-ring
- Side positioning D-rings
- Friction buckle torso adjusters
- Mating buckle chest
- Tongue buckle legs
- Shoulder pads
- Floating waist pad
- Weight Capacity ANSI 130-310 lbs., OSHA 420 lbs.
- ANSI Z359.11-2021, OSHA 1926.502, 1910.140

**V-Line Harness Sizes**

	SMALL	MEDIUM	LARGE	XLARGE	2X
1	FS99160-EFD-S	FS99160-EFD-M	FS99160-EFD-L	FS99160-EFD-XL	FS99160-EFD-2X
2	FS99160-E-QC-S	FS99160-E-QC-M	FS99160-E-QC-L	FS99160-E-QC-XL	FS99160-E-QC-2X
3	021-1617	021-1618	021-1619	021-1620	021-1621
4	FS99160-E-S	FS99160-E-M	FS99160-E-L	FS99160-E-XL	FS99160-E-2X



5

**V-Line Full Body Harness:**  
 Universal, 3D, MB Chest, TB Legs

**FS99285-E**

- Dorsal D-ring
- Side positioning D-rings
- Mating buckle torso adjusters
- Mating buckle chest
- Tongue buckle legs
- Universal sizing
- Weight Capacity ANSI 130-310 lbs., OSHA 420 lbs.
- ANSI Z359.11-2021, OSHA 1926.502, 1910.140



6

**V-Line Full Body Harness:**  
 Universal, 3D, MB Chest, FD, MB Legs

**FS99281-EFD**

- Dorsal and front D-rings
- Side positioning D-rings
- Mating buckle torso adjusters
- Mating buckle chest
- Mating buckle legs
- Universal sizing
- Weight Capacity ANSI 130-310 lbs., OSHA 420 lbs.
- ANSI Z359.11-2021, OSHA 1926.502, 1910.140



7

**V-Line Full Body Harness:**  
 Universal, 3D, MB Chest/Legs

**FS99281-E**

- Dorsal D-ring
- Side positioning D-rings
- Mating buckle torso adjusters
- Mating buckle chest
- Mating buckle legs
- Universal sizing
- Weight Capacity ANSI 130-310 lbs., OSHA 420 lbs.
- ANSI Z359.11-2021, OSHA 1926.502, 1910.140



8

**V-Line Crossover:**  
 Universal, 3D, MB Torso, FD, MB Legs

**FS99281-EFD-X**

- Crossover construction
- Dorsal and front D-rings
- Side positioning D-rings
- Mating buckle torso adjusters
- Mating buckle chest
- Mating buckle legs
- Universal sizing
- Weight Capacity ANSI 130-310 lbs., OSHA 420 lbs.
- ANSI Z359.11-2021, OSHA 1926.502, 1910.140

**V-Line Harness Sizes**

	UNIVERSAL
5	FS99285-E
6	FS99281-EFD
7	FS99281-E
8	FS99281-EFD-X





- 9** **V-Line Full Body Harness:**  
 Universal, 1D, QC Chest, TB Legs  
**FS99185-E-QC**
- Dorsal D-ring
  - Mating buckle torso adjusters
  - Quick-connect chest
  - Tongue buckle legs
  - Universal sizing
  - Weight Capacity ANSI 130-310 lbs., OSHA 420 lbs.
  - ANSI Z359.11-2021, OSHA 1926.502, 1910.140



- 10** **V-Line Full Body Harness:**  
 Universal, 1D, MB Chest, FD, TB Legs  
**FS99185-EFD**
- Dorsal and front D-rings
  - Mating buckle torso adjusters
  - Mating buckle chest
  - Tongue buckle legs
  - Universal sizing
  - Weight Capacity ANSI 130-310 lbs., OSHA 420 lbs.
  - ANSI Z359.11-2021, OSHA 1926.502, 1910.140



- 11** **V-Line Full Body Harness:**  
 Universal, 1D, MB Chest, TB Legs  
**FS99185-E**
- Dorsal D-ring
  - Mating buckle torso adjusters
  - Mating buckle chest
  - Tongue buckle legs
  - Universal sizing
  - Weight Capacity ANSI 130-310 lbs., OSHA 420 lbs.
  - ANSI Z359.11-2021, OSHA 1926.502, 1910.140



- 12** **V-Line Full Body Harness:**  
 Universal, 1D, MB Chest/Legs  
**FS99280-E**
- Dorsal D-ring
  - Mating buckle torso adjusters
  - Mating buckle chest
  - Mating buckle legs
  - Universal sizing
  - Weight Capacity ANSI 130-310 lbs., OSHA 420 lbs.
  - ANSI Z359.11-2021, OSHA 1926.502, 1910.140

**V-Line Harness Sizes**

UNIVERSAL	
9	FS99185-E-QC
10	FS99185-EFD
11	FS99185-E
12	FS99280-E

1

## ARC FLASH CONSTRUCTION HARNESSES: DE 3D, DE QC CHEST, DE FD, DE QC LEGS

020-1252

The Arc Flash Aramid Harness, built for utility and electrical workers, delivers dependable protection plus all-day comfort. Designed with our premium aramid ASTM approved webbing and Nomex® shoulder, waist and leg pads, our Arc Flash harnesses feature either coated, corrosion-resistant dielectric hardware or hardware protected by our unique component backer.

- Dielectric dorsal and front D-rings
- Dielectric side positioning D-rings
- Dielectric mating buckle torso adjusters
- Dielectric quick-connect chest, legs and belt
- Shoulder, waist and leg pads
- 40Cal/700F rated aramid webbing
- Weight Capacity ANSI 130-310 lbs., OSHA 420 lbs.
- ANSI Z359.11-2021, OSHA 1926.502, 1910.140, ASTM F887



Dielectric Front D-Ring



Aramid Webbing



Dielectric Dorsal D-Ring



Dielectric Side Positioning D-Ring



Dielectric Quick-Connect Chest



Dielectric Mating Buckle Torso Adjusters

## ARC FLASH vs. DIELECTRIC



**ARC FLASH** harnesses are only required to meet the ASTM F887 standard. This standard does not address the arc control capability of any buckles or hardware. Product may meet the Arc Flash standard, but do not include the dielectric hardware. These still qualify under the ASTM standard.



2

### Arc Flash Construction Harness:

DE 3D, DE QC Chest, TB Legs  
**020-1260**

- Dielectric dorsal D-ring
- Dielectric side positioning D-rings
- Dielectric mating buckle torso adjusters
- Dielectric quick-connect chest
- Tongue buckle legs and belt
- Shoulder, waist and leg pads
- 40Cal/700F rated aramid webbing
- Weight Capacity ANSI 130-310 lbs., OSHA 420 lbs.
- ANSI Z359.11-2021, OSHA 1926.502, 1910.140, ASTM F887



3

### Arc Flash Construction Harness:

3D, MB Chest, TB Legs  
**020-1346**

- Dorsal D-ring
- Side positioning D-rings
- Friction buckle torso adjusters
- Mating buckle chest
- Tongue buckle legs and belt
- Shoulder, waist and leg pads
- 40Cal/700F rated aramid webbing
- Weight Capacity ANSI 130-310 lbs., OSHA 420 lbs.
- ANSI Z359.11-2021, OSHA 1926.502, 1910.140, ASTM F887



4

### Arc Flash Full Body Harness:

DE 3D, DE QC Chest, DE FD, TB Legs  
**020-1268**

- Dielectric dorsal and front D-rings
- Dielectric side positioning D-rings
- Dielectric mating buckle torso adjusters
- Dielectric quick-connect chest
- Tongue buckle legs
- Shoulder and leg pads
- 40Cal/700F rated aramid webbing
- Weight Capacity ANSI 130-310 lbs., OSHA 420 lbs.
- ANSI Z359.11-2021, OSHA 1926.502, 1910.140, ASTM F887

#### Arc Flash Harness Sizes

	XSMALL	SMALL	MEDIUM	LARGE	XLARGE	2X	3X
1	020-1250	020-1251	020-1252	020-1253	020-1254	020-1255	020-1256
2	020-1258	020-1259	020-1260	020-1261	020-1262	020-1263	020-1264
3	020-1344	020-1345	020-1346	020-1347	020-1348	020-1349	020-1350
4	020-1266	020-1267	020-1268	020-1269	020-1270	020-1271	020-1272



5

**Arc Flash Full Body Harness:**

DE 3D, DE QC Chest, DE FD, DE QC Legs

**022-1038**

- Dielectric dorsal and front D-rings
- Dielectric side positioning D-rings
- Dielectric mating buckle torso adjusters
- Dielectric quick-connect chest and legs
- Shoulder and leg pads
- 40Cal/700F rated aramid webbing
- Weight Capacity ANSI 130-310 lbs., OSHA 420 lbs.
- ANSI Z359.11-2021, OSHA 1926.502, 1910.140, ASTM F887



6

**Arc Flash Full Body Harness:**

DE 3D, DE QC Chest/ Legs

**022-1016**

- Dielectric dorsal D-ring
- Dielectric side positioning D-rings
- Dielectric mating buckle torso adjusters
- Dielectric quick-connect chest and legs
- Shoulder and leg pads
- 40Cal/700F rated aramid webbing
- Weight Capacity ANSI 130-310 lbs., OSHA 420 lbs.
- ANSI Z359.11-2021, OSHA 1926.502, 1910.140, ASTM F887



7

**Arc Flash Full Body Harness:**

DE 3D, DE MB Chest/Legs

**020-1276**

- Dielectric dorsal D-ring
- Dielectric side positioning D-rings
- Dielectric mating buckle torso adjusters
- Dielectric mating buckle chest and legs
- Shoulder and leg pads
- 40Cal/700F rated aramid webbing
- Weight Capacity ANSI 130-310 lbs., OSHA 420 lbs.
- ANSI Z359.11-2021, OSHA 1926.502, 1910.140, ASTM F887



8

**Arc Flash Full Body Harness:**

DE 1D, DE MB Chest, TB Legs

**020-1284**

- Dielectric dorsal D-ring
- Dielectric mating buckle torso adjusters
- Dielectric mating buckle chest
- Tongue buckle legs
- Shoulder and leg pads
- 40Cal/700F rated aramid webbing
- Weight Capacity ANSI 130-310 lbs., OSHA 420 lbs.
- ANSI Z359.11-2021, OSHA 1926.502, 1910.140, ASTM F887

**Arc Flash Harness Sizes**

	XSMALL	SMALL	MEDIUM	LARGE	XLARGE	2X	3X
5	022-1036	022-1037	022-1038	022-1039	022-1040	022-1041	022-1042
6	022-1014	022-1015	022-1016	022-1017	022-1018	022-1019	022-1020
7	020-1274	020-1275	020-1276	020-1277	020-1278	020-1279	020-1280
8	020-1282	020-1283	020-1284	020-1285	020-1286	020-1287	020-1288



**9 Arc Flash Full Body Harness:**  
 DE 1D, DE MB Chest/Legs  
**020-1292**

- Dielectric dorsal D-ring
- Dielectric mating buckle torso adjusters
- Dielectric mating buckle chest and legs
- Shoulder and leg pads
- 40Cal/700F rated aramid webbing
- Weight Capacity ANSI 130-310 lbs., OSHA 420 lbs.
- ANSI Z359.11-2021, OSHA 1926.502, 1910.140, ASTM F887



**10 Arc Flash Full Body Harness:**  
 1D, MB Chest, TB Legs  
**020-1354**

- Dorsal D-ring
- Friction buckle torso adjusters
- Mating buckle chest
- Tongue buckle legs
- Shoulder and leg pads
- 40Cal/700F rated aramid webbing
- Weight Capacity ANSI 130-310 lbs., OSHA 420 lbs.
- ANSI Z359.11-2021, OSHA 1926.502, 1910.140, ASTM F887



**11 Arc Flash Full Body Harness:**  
 DE 1D, DE QC Chest/Legs  
**022-1982**

- Dielectric dorsal D-ring
- Dielectric mating buckle torso adjusters
- Dielectric quick-connect chest and legs
- Shoulder and leg pads
- 40Cal/700F rated aramid webbing
- Weight Capacity ANSI 130-310 lbs., OSHA 420 lbs.
- ANSI Z359.11-2021, OSHA 1926.502, 1910.140, ASTM F887



**Arc Flash Harness Sizes**

	XSMALL	SMALL	MEDIUM	LARGE	XLARGE	2X	3X
9	020-1290	020-1291	020-1292	020-1293	020-1294	020-1295	020-1296
10	020-1352	020-1353	020-1354	020-1355	020-1356	020-1357	020-1358
11	022-1980	022-1981	022-1982	022-1983	022-1984	022-1985	022-1986

12

**ARC FLASH FULL BODY HARNESS: DE 1D, SOFT STERNAL LOOP, DE MB TORSO, DE QC LEGS SW77125-UTQC**

The Arc Flash Nylon Harness delivers comfort and easy movement in the confines of a bucket and other arc-rated applications. Equipped with heavy-duty mill spec ASTM approved webbing and coated, corrosion-resistant dielectric hardware.

- Pullover construction
- Dielectric dorsal D-ring
- Soft loop front D-ring
- Dielectric mating buckle torso adjusters
- Dielectric quick-connect legs
- 40Cal/550F rated nylon webbing
- Weight Capacity ANSI 130-310 lbs., OSHA 420 lbs.
- ANSI Z359.11-2021, OSHA 1926.502, 1910.140, ASTM F887

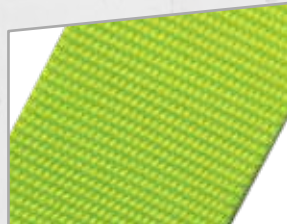

ASTM/NFPA Approved Webbing



Load Indicator



Dorsal D-Ring



Torso Adjusters



Quick-Connect Legs



Soft Loop Front D-Ring



13

**Arc Flash Full Body Harness:**

Soft Dorsal & Sternal Loop, DE MB Torso, DE QC Legs

**SW77125-UTQC-SL**

- Pullover construction
- Soft loop dorsal and front D-rings
- Dielectric mating buckle torso adjusters
- Dielectric quick-connect legs
- 40Cal/550F rated nylon webbing
- Weight Capacity ANSI 130-310 lbs., OSHA 420 lbs.
- ANSI Z359.11-2021, OSHA 1926.502, 1910.140, ASTM F887



14

**Arc Flash Full Body Harness:**

DE 1D, DE MB Torso, DE QC Chest/Legs

**SW77225-UT3QC**

- Dielectric dorsal D-ring
- Dielectric mating buckle torso adjusters
- Dielectric quick-connect chest and legs
- 40Cal/550F rated nylon webbing
- Weight Capacity ANSI 130-310 lbs., OSHA 420 lbs.
- ANSI Z359.11-2021, OSHA 1926.502, 1910.140, ASTM F887



15

**Arc Flash Full Body Harness:**

DE 1D, DE MB Torso, DE MB Chest, DE QC Legs

**SW77225-UTQC**

- Dielectric dorsal D-ring
- Dielectric mating buckle torso adjusters
- Dielectric mating buckle chest
- Dielectric quick-connect legs
- 40Cal/550F rated nylon webbing
- Weight Capacity ANSI 130-310 lbs., OSHA 420 lbs.
- ANSI Z359.11-2021, OSHA 1926.502, 1910.140, ASTM F887



16

**Arc Flash Full Body Harness:**

Soft Loop, 1D, DE MB Torso, DE MB Chest, DE QC Legs

**SW77225-UT2QCSL**

- Soft loop dorsal D-ring
- Dielectric mating buckle torso adjusters
- Dielectric mating buckle chest
- Dielectric quick-connect legs
- 40Cal/550F rated nylon webbing
- Weight Capacity ANSI 130-310 lbs., OSHA 420 lbs.
- ANSI Z359.11-2021, OSHA 1926.502, 1910.140, ASTM F887

**Arc Flash Harness Sizes**

	XSMALL	SMALL/MEDIUM	LARGE/XLARGE	2X	3X	4X
12	SW77125-UTQC-XS	SW77125-UTQC-S/M	SW77125-UTQC-L/XL	SW77125-UTQC-2X	SW77125-UTQC-3X	SW77125-UTQC-4X
13	SW77125-UTQC-SL-XS	SW77125-UTQC-SL-S/M	SW77125-UTQC-SL-L/XL	SW77125-UTQC-SL-2X	SW77125-UTQC-SL-3X	SW77125-UTQC-SL-4X
14	SW77225-UT3QC-XS	SW77225-UT3QC-S/M	SW77225-UT3QC-L/XL	SW77225-UT3QC-2X	SW77225-UT3QC-3X	SW77225-UT3QC-4X
15	SW77225-UTQC-XS	SW77225-UTQC-S/M	SW77225-UTQC-L/XL	SW77225-UTQC-2X	SW77225-UTQC-3X	SW77225-UTQC-4X
16	SW77225-UT2QCSL-XS	SW77225-UT2QCSL-S/M	SW77225-UT2QCSL-L/XL	SW77225-UT2QCSL-2X	SW77225-UT2QCSL-3X	SW77225-UT2QCSL-4X



1

**Welding Full Body Harness:**  
3D, Aramid Web, MB Chest/Legs  
**FS77326-FR**

- Dorsal D-ring
- Side positioning D-rings
- Friction buckle torso adjusters
- Mating buckle chest and legs
- 40Cal/750°F char rated aramid webbing
- Lightweight, premium webbing
- Weight Capacity ANSI 130-310 lbs., OSHA 420 lbs.
- ANSI Z359.11-2021, OSHA 1926.502, 1910.140



2

**Welding Full Body Harness:**  
1D, Aramid Web, MB Chest/Legs  
**FS77325-FR**

- Dorsal D-ring
- Friction buckle torso adjusters
- Mating buckle chest and legs
- 40Cal/750°F char rated aramid webbing
- Lightweight, premium webbing
- Weight Capacity ANSI 130-310 lbs., OSHA 420 lbs.
- ANSI Z359.11-2021, OSHA 1926.502, 1910.140



3

**Welding Full Body Harness:**  
3D, MB Chest/Legs  
**FS77426-WE**

- Dorsal D-ring
- Side positioning D-rings
- Friction buckle torso adjusters
- Mating buckle chest and legs
- 40Cal/700°F char rated aramid webbing
- Weight Capacity ANSI 130-310 lbs., OSHA 420 lbs.
- ANSI Z359.11-2021, OSHA 1926.502, 1910.140



4

**Welding Full Body Harness:**  
1D, MB Chest/Legs  
**FS77425-WE**

- Dorsal D-ring
- Friction buckle torso adjusters
- Mating buckle chest and legs
- 40Cal/700°F char rated aramid webbing
- Weight Capacity ANSI 130-310 lbs., OSHA 420 lbs.
- ANSI Z359.11-2021, OSHA 1926.502, 1910.140

**Welding Harness Sizes**

	XSMALL	SMALL	MEDIUM	LARGE	XL	2X	3X
1	FS77326-FR-XS	FS77326-FR-S	FS77326-FR-M	FS77326-FR-L	FS77326-FR-XL	FS77326-FR-2X	FS77326-FR-3X
2	FS77325-FR-XS	FS77325-FR-S	FS77325-FR-M	FS77325-FR-L	FS77325-FR-XL	FS77325-FR-2X	FS77325-FR-3X
3	FS77426-WE-XS	FS77426-WE-S/M		FS77426-WE-L/XL		FS77426-WE-2X	FS77426-WE-3X
4	FS77425-WE-XS	FS77425-WE-S/M		FS77425-WE-L/XL		FS77425-WE-2X	FS77425-WE-3X





**1** **Heavyweight Full Body Harness:**  
3D, MB Chest, TB Legs  
**SW99281-HW**

- Dorsal D-ring
- Side positioning D-rings
- Friction buckle torso adjusters
- Mating buckle chest
- Tongue buckle legs
- Shoulder pad
- Weight Capacity ANSI 130-310 lbs., OSHA 420 lbs.
- ANSI Z359.11-2021, OSHA 1926.502, 1910.140



**2** **Heavyweight Full Body Harness:**  
1D, MB Chest, TB Legs  
**SW99280-HW**

- Dorsal D-ring
- Friction buckle torso adjusters
- Mating buckle chest
- Tongue buckle legs
- Shoulder pad
- Weight Capacity ANSI 130-310 lbs., OSHA 420 lbs.
- ANSI Z359.11-2021, OSHA 1926.502, 1910.140

**Heavyweight Harness Sizes**

	3X/4X	5X
1	SW99281-HW	SW99281-HW-5X
2	SW99280-HW	SW99280-HW-5X



**3** **Oil & Gas Full Body Harness:**  
1D, Derrick Belt, Alu QC Chest, FD, TB Legs  
**FS77635-OD**

- Dorsal and front D-rings
- 18" Dorsal D-ring Extender
- Integrated derrick belt
- Friction buckle torso adjusters
- Quick-connect chest
- Tongue buckle legs
- Weight Capacity ANSI 130-310 lbs., OSHA 420 lbs.
- ANSI Z359.11-2021, OSHA 1926.502, 1910.140



**4** **Replacement Derrick Belt**  
**FS77635-OD-PAD**

- Quick-connect attachment
- Tongue buckle waist adjustment
- Zinc plated steel components
- Rugged double layered webbing with reinforcement
- OSHA 1926.502, 1910.66

**Specialty Harness Sizes**

	SMALL/MEDIUM	LARGE/XLARGE	2X
3	FS77635-OD-S/M	FS77635-OD-L/XL	FS77635-OD-2X
4	FS77635-OD-PAD-S/M	FS77635-OD-PAD-L/XL	FS77635-OD-PAD-2X

1

## WIND & TOWER HARNESS: ALU 5D, REMOVABLE SEAT, ALU QC LEGS

FS227T

The Wind & Tower Harness is a premium offering for climbing, rescue and rope access applications. This uniquely designed step-in-style harness features heavy-duty webbing and thick shoulder, waist and leg padding for all-day comfort. Offered with all aluminum components for weight reduction and a removable positioning suspension seat.

- Step-in style construction
- Dorsal, sternal and waist D-rings
- Side positioning D-rings
- Quick torso adjusters
- Aluminum carabiner front connection
- Quick-connect legs
- Adjustable rear leg straps
- Removable lanyard keepers with split-D-rings
- Removable positioning/suspension seat
- Weight Capacity ANSI 130-310 lbs., OSHA 420 lbs.
- ANSI Z359.11-2021, OSHA 1926.502, 1910.140



Dorsal D-Ring



Front Sternal D-Ring



Front Waist D-Ring



Torso Adjuster



Removable Keeper



Quick Connect Legs

Tower Seat (Sold Separately)

Part Number	Description
021-9058	Removable Tower Suspension Seat



**2** **Wind & Tower Harness:**  
 Alu 5D, Alu QC Legs  
**FS227**

- Step-in style construction
- Dorsal, sternal and waist D-rings
- Side positioning D-rings
- Quick torso adjusters
- Aluminum carabiner front connection
- Quick-connect legs
- Adjustable rear leg straps
- Removable lanyard keepers with split-D-rings
- Weight Capacity ANSI 130-310 lbs., OSHA 420 lbs.
- ANSI Z359.11-2021, OSHA 1926.502, 1910.140



**3** **Wind & Tower Construction Harness:**  
 Alu 3D, Alu QC Chest, Alu FD, TB Legs  
**FS377**

- Dorsal and front D-rings
- Side positioning D-rings
- Quick torso adjusters
- Quick-connect chest
- Tongue buckle legs
- Shoulder, waist and leg pads
- Weight Capacity ANSI 130-310 lbs., OSHA 420 lbs.
- ANSI Z359.11-2021, OSHA 1926.502, 1910.140



**4** **Wind & Tower Crossover Harness:**  
 Alu 3D, Alu QC Torso, Alu FD, Alu QC Legs  
**FS9000-COS**

- Crossover construction
- Dorsal and front D-rings
- Side positioning D-rings
- Quick torso adjusters
- Quick-connect legs
- Weight Capacity ANSI 130-310 lbs., OSHA 420 lbs.
- ANSI Z359.11-2021, OSHA 1926.502, 1910.140

**Wind & Tower Harness Sizes**

	SMALL	MEDIUM	LARGE	XLARGE	2X	UNIVERSAL
1	FS227T-S/M		FS227T-L/XL		FS227T-2X	–
2	FS227-S/M		FS227-L/XL		FS227-2X	–
3	FS377-S	FS377-M	FS377-L	FS377-XL	FS377-2X	–
4	–	–	–	–	–	FS9000-COS



1

**REFLECTIVE FULL BODY HARNESS:  
1D, MB CHEST, TB LEGS, MINING BELT**  
021-1811

The Reflective Full Body Harness is designed with the mining industry in mind. Features reflective webbing to ensure visibility in dark environments and hands-free storage with multiple attachments plus easy pull-down adjustment for a comfortable fit.

- Dorsal D-ring
- Fixed mating buckle chest
- Friction torso adjusters
- Tongue buckle legs
- Removable shoulder pad
- Tool straps, radio loop and tool rings
- 2 Replacement lanyard keepers
- Adjustable mining belt for lamp and battery
- Hi-vis reflective webbing
- Weight Capacity ANSI 130-310 lbs., OSHA 420 lbs.
- ANSI Z359.11-2021, ANSI/ISEA 107-2020, OSHA 1926.502, 1910.140



Reflective Webbing



Adjustable Mining Belt



Dorsal D-Ring



Shoulder Pad



Radio/Tool Rings



Tool Straps

Reflective Full Body Harness Sizes (Mining)

	SMALL	MEDIUM	LARGE	XLARGE	2X	3X
1	021-1810	021-1811	021-1812	021-1813	021-1814	021-1815



2

**Reflective Full Body Harness:**  
1D, MB Chest, TB Legs  
**FS-HIVIS185**

- Dorsal D-ring
- Friction buckle torso adjusters
- Mating buckle chest
- Tongue buckle legs
- Shoulder pad
- Hi-vis reflective webbing
- Weight Capacity ANSI 130-310 lbs., OSHA 420 lbs.
- ANSI Z359.11-2021, ANSI/ISEA 107-2020, OSHA 1926.502, 1910.140

**Reflective Full Body Harness Sizes**

	SMALL/MEDIUM	LARGE/XLARGE	2X
2	FS-HIVIS185-S/M	FS-HIVIS185-L/XL	FS-HIVIS185-2X



**INTERESTED IN THE  
NEWEST RELEASES  
FOR HARNESSES?**

Scan this code to view them now!





# LANYARDS

Cable or web, single or dual leg, internal or external energy absorber— these are just a few questions to ask when choosing the best lanyard for the job. With more than a dozen lanyard categories, our experts can help you quickly select the right one to keep your team moving safe onsite.



## PRO

These lanyards utilize external tear webbing for deceleration and force management. Built with premium materials including forged hooks and ballistic polyester shock pack covers with integrated protective label cover.



## PRO

### STRETCH

These lanyards use an external tear webbing with shock cover combined with elasticated webbing lanyard legs. This allows the webbing to contract when not in use reducing trip or snag hazards. Offered with forged steel and aluminum hooks.



## PRO

### STRETCH INTERNAL

These lanyards use a specially woven webbing of POY and elasticized yarns. This allows the lanyard to stretch while still providing required ANSI deceleration and force management necessary in a fall event. Equipped with forged steel and aluminum hooks.



### PRO INTERNAL

These lanyards use specially woven webbing with POY as the core, which acts as the deceleration and force management system. Equipped with forged hooks and durable label covers.



### V-LINE

Our economical external tear webbing lanyards built with a durable shock pack cover with integrated protective label cover and stamped steel hooks.



### V-LINE STRETCH INTERNAL

Our economical stretch internal lanyards use tubular webbing and a POY/elastic filled core. Equipped with a protective label cover and stamped steel hooks.



### V-LINE INTERNAL

Our economical internal construction lanyards. Built with tubular webbing and a POY filled core. Equipped with a protective label cover and stamped steel hooks.



### LEADING EDGE

The one solution for all. Versatile leading edge cable lanyard offering fall protection for users 130-310 lbs. (ANSI) and up to 420 lbs. (OSHA). Meets the requirements for 6' and 12' freefall as well as leading edge for both.



### ARC FLASH

This is a highly specialized lanyard solution. Built with the best materials, these products provide the safety and security necessary when working at height in arc event rated areas.



### ARC FLASH INTERNAL

Highly specialized lanyards with a shock-absorbing core so no external shock pack is required. Premium materials ensure safety at height in arc event rated areas.



### WELDING

Engineered for tough environments specific to workers exposed to flame, fire or other welding processes. These lanyards are built with premium aramid webbing and materials.



### HEAVYWEIGHT

These 6' lanyards feature heavy-duty webbing and forged hooks especially for workers 310 lbs. to 420 lbs.



### RESTRAINT

A line of easy to use, non-energy absorbing lanyards to meet all of your fixed or restraint positioning needs. Built to prevent a user from accessing an area where there is a risk of falling.



### POSITIONING ASSEMBLIES

Built for a variety of positioning applications. Options include rope for use in tower and utilities as well as chain or web for use on rebar and concrete.



### D-RING EXTENDERS

Various configurations and lengths of dorsal D-ring extensions to make accessing the D-ring easier and allow for quick attachment and release.

**PRO**

**6' ENERGY ABSORBING LANYARD:  
DUAL LEG, REBAR HOOKS**

FS566

The PRO Energy Absorbing Lanyard is built for performance with UV and abrasion resistant hi-vis green webbing, dual legs for 100% tie-off and efficient tear webbing to reduce fall arrest force.

- 1" polyester hi-vis webbing
- Forged steel hooks
- Ballistic shock/label cover
- Minimum Breaking Strength: 5,000 lbs.
- Weight Capacity ANSI 130-310 lbs.
- ANSI Z359.13-2013, OSHA 1926.502, 1910.140, 1910.66

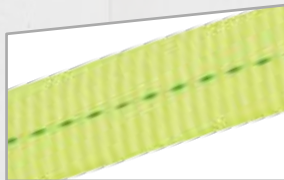

Hi-Vis Webbing



Durable Construction

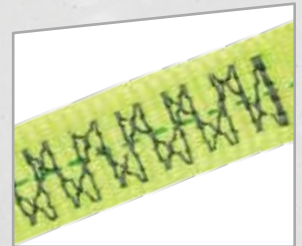

High-Strength Polyester Stitching



Forged Steel Rebar Hooks



Ballistic Shock Cover



3,600 lbs Gate-Rated

**4' EA Lanyard Rebar Hook Option**

Part Number	Description	Length
FS566-4	PRO 4' Energy Absorbing Lanyard: Dual Leg, Rebar Hooks	4 ft.





**PRO 6' Energy Absorbing Lanyard:**  
Rebar Hook

**FS565**

- 1" polyester hi-vis webbing
- Forged steel hooks
- Ballistic shock/label cover
- Minimum Breaking Strength: 5,000 lbs.
- Weight Capacity ANSI 130-310 lbs.
- ANSI Z359.13-2013, OSHA 1926.502, 1910.140, 1910.66



**PRO 6' Energy Absorbing Lanyard:**  
Dual Leg, Snap Hooks

**FS561**

- 1" polyester hi-vis webbing
- Forged steel hooks
- Ballistic shock/label cover
- Minimum Breaking Strength: 5,000 lbs.
- Weight Capacity ANSI 130-310 lbs.
- ANSI Z359.13-2013, OSHA 1926.502, 1910.140, 1910.66



**PRO 6' Energy Absorbing Lanyard:**  
Snap Hook

**FS560**

- 1" polyester hi-vis webbing
- Forged steel hooks
- Ballistic shock/label cover
- Minimum Breaking Strength: 5,000 lbs.
- Weight Capacity ANSI 130-310 lbs.
- ANSI Z359.13-2013, OSHA 1926.502, 1910.140, 1910.66



**PRO 6' Energy Absorbing Lanyard:**  
Soft Loop

**FS560-SE**

- 1" polyester hi-vis webbing
- Soft loop attachment
- Forged steel hook
- Ballistic shock/label cover
- Minimum Breaking Strength: 5,000 lbs.
- Weight Capacity ANSI 130-310 lbs.
- ANSI Z359.13-2013, OSHA 1926.502, 1910.140, 1910.66

**EA Lanyard Snap Hook Options**

PART NUMBER	DESCRIPTION	LENGTH
FS560-4	PRO 4' Energy Absorbing Lanyard: Snap Hook	4 ft.
FS560-3	PRO 3' Energy Absorbing Lanyard: Snap Hook	3 ft.



**PRO 4'-6' Adjustable Energy Absorbing Lanyard: Soft Loop**

**FS560-SE-AJ**

- Adjustable from 4'-6'
- 1" polyester hi-vis webbing
- Soft loop attachment
- Forged steel hook
- Ballistic shock/label cover
- Minimum Breaking Strength: 5,000 lbs.
- Weight Capacity ANSI 130-310 lbs.
- ANSI Z359.13-2013, OSHA 1926.502, 1910.140, 1910.66



**PRO 4'-6' Adjustable Energy Absorbing Lanyard: Dual Leg, Rebar Hooks**

**FS566-AJ**

- Adjustable from 4'-6'
- 1" polyester hi-vis webbing
- Forged steel hooks
- Ballistic shock/label cover
- Minimum Breaking Strength: 5,000 lbs.
- Weight Capacity ANSI 130-310 lbs.
- ANSI Z359.13-2013, OSHA 1926.502, 1910.140, 1910.66



**PRO 4'-6' Adjustable Energy Absorbing Lanyard: Rebar Hook**

**FS565-AJ**

- Adjustable from 4'-6'
- 1" polyester hi-vis webbing
- Forged steel hooks
- Ballistic shock/label cover
- Minimum Breaking Strength: 5,000 lbs.
- Weight Capacity ANSI 130-310 lbs.
- ANSI Z359.13-2013, OSHA 1926.502, 1910.140, 1910.66



**PRO 4'-6' Adjustable Energy Absorbing Lanyard: Dual Leg, Snap Hooks**

**FS561-AJ**

- Adjustable from 4'-6'
- 1" polyester hi-vis webbing
- Forged steel hooks
- Ballistic shock/label cover
- Minimum Breaking Strength: 5,000 lbs.
- Weight Capacity ANSI 130-310 lbs.
- ANSI Z359.13-2013, OSHA 1926.502, 1910.140, 1910.66

**Single Leg Option**

PART NUMBER	DESCRIPTION
FS560-AJ	PRO 4'-6' Adjustable Snap Hook



**PRO 6' Tie-Back Energy Absorbing Lanyard:** Dual Leg, Adjustable Ring

**FS456**

- Adjustable tie-back rings
- 1" polyester hi-vis webbing
- Forged steel hooks
- Ballistic shock/label cover
- Minimum Breaking Strength: 5,000 lbs.
- Weight Capacity ANSI 130-310 lbs.
- ANSI Z359.13-2013, OSHA 1926.502, 1910.140, 1910.66

**Single Leg Option**

PART NUMBER	DESCRIPTION
FS455	PRO 6' Tie-Back Adjustable Ring



**PRO 6' Tie-Back Energy Absorbing Lanyard:** Dual Leg

**FS451**

- 1" polyester hi-vis webbing
- Forged steel snap hook
- Forged tie-back hooks, 5K gate
- Ballistic shock/label cover
- Minimum Breaking Strength: 5,000 lbs.
- Weight Capacity ANSI 130-310 lbs.
- ANSI Z359.13-2013, OSHA 1926.502, 1910.140, 1910.66

**Single Leg Option**

PART NUMBER	DESCRIPTION
FS450	PRO 6' Tie-Back



**PRO 6' Cable Energy Absorbing Lanyard:** Dual Leg, Snap Hooks

**FS561-CA**

- 5/16" coated cable
- Forged steel hooks
- Ballistic shock/label cover
- Minimum Breaking Strength: 5,000 lbs.
- Weight Capacity ANSI 130-310 lbs.
- ANSI Z359.13-2013, OSHA 1926.502, 1910.140, 1910.66

**Single Leg Option**

PART NUMBER	DESCRIPTION
FS560-CA	PRO 6' Cable Snap Hook



**PRO 6' Rope Energy Absorbing Lanyard:** Dual Leg, Snap Hooks

**FS33216**

- 5/8" polyester rope
- Forged steel hooks
- Ballistic shock/label cover
- Minimum Breaking Strength: 5,000 lbs.
- Weight Capacity ANSI 130-310 lbs.
- ANSI Z359.13-2013, OSHA 1926.502, 1910.140, 1910.66

**Single Leg Option**

PART NUMBER	DESCRIPTION
FS33215	PRO 6' Rope Snap Hook

## PRO

### 6' STRETCH ENERGY ABSORBING LANYARD: 12' FF DUAL LEG, ALU REBAR HOOKS, RESCUE RINGS

FS88761-FF-ALU

The PRO 6' Stretch Energy Absorbing Lanyard expands reach and range of movement, while reducing tripping, snag or other hazards. Constructed with elasticated webbing, dual legs for 100% tie-off and efficient tear webbing to reduce fall arrest force.

- 12' free fall lanyard
- Stretches from 4' to 6'
- Forged aluminum hooks
- Fixed aluminum rescue D-rings
- Ballistic shock/label cover
- Minimum Breaking Strength: 5,000 lbs.
- Weight Capacity ANSI 130-310 lbs., OSHA 420 lbs.
- ANSI Z359.13-2013, OSHA 1926.502, 1910.140, 1910.66



Elasticated Webbing



Ballistic Shock Cover



Rescue D-Rings

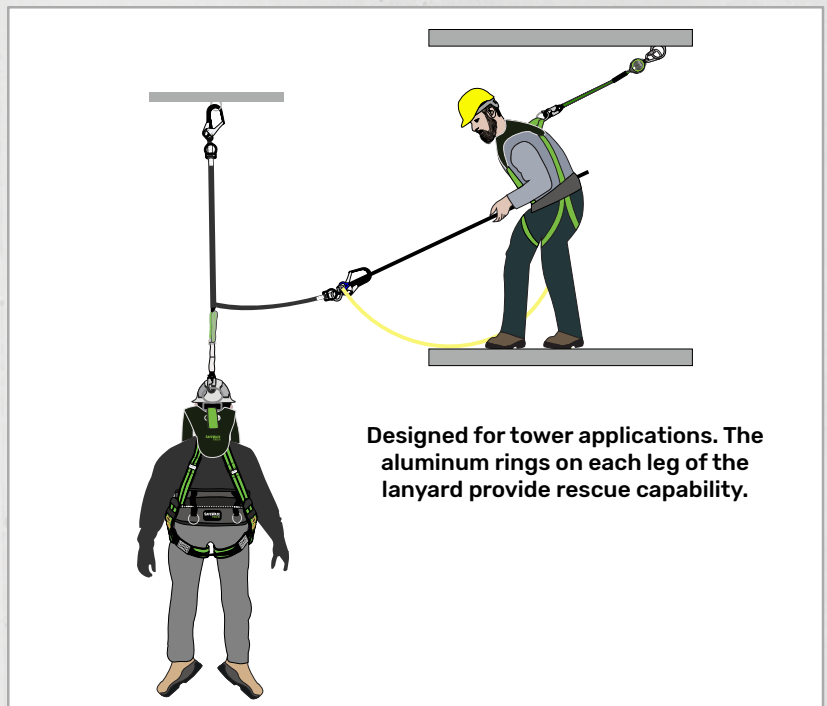

Designed for tower applications. The aluminum rings on each leg of the lanyard provide rescue capability.



**PRO 6' Stretch Energy Absorbing Lanyard:**  
12' FF Dual Leg, Alu Rebar Hooks

**88761-FF-RB-AL**

- 12' free fall lanyard
- Stretches from 4' to 6'
- Forged aluminum hooks
- Ballistic shock/label cover
- Minimum Breaking Strength: 5,000 lbs.
- Weight Capacity ANSI 130-310 lbs., OSHA 420 lbs.
- ANSI Z359.13-2013, OSHA 1926.502, 1910.140, 1910.66



**PRO 6' Stretch Energy Absorbing Lanyard:**  
12' FF Dual Leg, Snap Hooks

**FS88761-FF**

- 12' free fall lanyard
- Stretches from 4' to 6'
- Forged steel hooks
- Ballistic shock/label cover
- Minimum Breaking Strength: 5,000 lbs.
- Weight Capacity ANSI 130-310 lbs., OSHA 420 lbs.
- ANSI Z359.13-2013, OSHA 1926.502, 1910.140, 1910.66



**PRO 6' Stretch Energy Absorbing Lanyard:**  
12' FF Snap Hook

**FS88760-FF**

- 12' free fall lanyard
- Stretches from 4' to 6'
- Forged steel hooks
- Ballistic shock/label cover
- Minimum Breaking Strength: 5,000 lbs.
- Weight Capacity ANSI 130-310 lbs., OSHA 420 lbs.
- ANSI Z359.13-2013, OSHA 1926.502, 1910.140, 1910.66



**PRO 6' Stretch Energy Absorbing Lanyard:**  
Dual Leg, Rebar Hooks

**FS576**

- Stretches from 4' to 6'
- Forged steel hooks
- Ballistic shock/label cover
- Minimum Breaking Strength: 5,000 lbs.
- Weight Capacity ANSI 130-310 lbs.
- ANSI Z359.13-2013, OSHA 1926.502, 1910.140, 1910.66



**PRO 6' Stretch Energy Absorbing Lanyard:**  
Rebar Hook

**FS575**

- Stretches from 4' to 6'
- Forged steel hooks
- Ballistic shock/label cover
- Minimum Breaking Strength: 5,000 lbs.
- Weight Capacity ANSI 130-310 lbs.
- ANSI Z359.13-2013, OSHA 1926.502, 1910.140, 1910.66



**PRO 6' Stretch Energy Absorbing Lanyard:**  
Dual Leg, Snap Hooks

**FS571**

- Stretches from 4' to 6'
- Forged steel hooks
- Ballistic shock/label cover
- Minimum Breaking Strength: 5,000 lbs.
- Weight Capacity ANSI 130-310 lbs.
- ANSI Z359.13-2013, OSHA 1926.502, 1910.140, 1910.66



**PRO 6' Stretch Energy Absorbing Lanyard:**  
Snap Hook

**FS570**

- Stretches from 4' to 6'
- Forged steel hooks
- Ballistic shock/label cover
- Minimum Breaking Strength: 5,000 lbs.
- Weight Capacity ANSI 130-310 lbs.
- ANSI Z359.13-2013, OSHA 1926.502, 1910.140, 1910.66



**PRO 6' Stretch Energy Absorbing Lanyard:**  
Rebar Hooks, Rescue Rings

**FS578**

- Stretches from 4' to 6'
- Forged steel hooks
- Fixed rescue rings
- Ballistic shock/label cover
- Minimum Breaking Strength: 5,000 lbs.
- Weight Capacity ANSI 130-310 lbs.
- ANSI Z359.13-2013, OSHA 1926.502, 1910.140, 1910.66

## CHOOSING THE RIGHT LANYARD

In a personal fall arrest system (PFAS), a lanyard connects your harness to an anchor point or to a horizontal or vertical lifeline, which acts as an intermediate connection to the anchor.

While lanyards are typically 6' in length, shorter and longer options are available. Always select the shortest possible lanyard. Lanyards should be long enough to allow adequate job site work without creating undue free fall distance.

Even a minimal fall can create tremendous force. For example, a 200 lb. worker falling 10 feet is subject to 8,000 lbs. of force in an abrupt dynamic drop. A properly selected and installed PFAS lanyard can drastically reduce the force to below 1,800 lbs., preventing serious injury.

### When selecting the best lanyard for the job, ask:

- What is the fall clearance to the next level?
- Where is the anchor point located, above or below the harness D-ring?
- Will you plan for fall arrest or eliminate the hazard by using a positioning lanyard?
- Will you be working near or over what ANSI defines as a leading edge?
- What is the right material for your lanyard based on the environment?
- What lanyard connectors do I need to properly tie off?

### LANYARD TYPES

- **Energy Absorbing Lanyards** – Built with an external or internal energy absorption system engineered to arrest the user and reduce the forces inflicted upon the body in a fall event.
- **Positioning Lanyards** – Built without an energy absorption system and used mainly for positioning or restraint situations that eliminate the likelihood of a fall event.

### LANYARD CONSTRUCTIONS

- **6' Free Fall** – For use at or above the dorsal D-ring to prevent a free fall greater than 6 feet.
- **12' Free Fall** – For use in foot level anchorage applications with a specialized absorber to handle the 12 foot free fall.
- **Single Leg** – One connection point for simplicity and weight reduction.
- **Dual Leg** – Two connection points for continuous attachment to an anchor.

### LANYARD MATERIALS

- **Webbing** – The flexible and dependable choice for most applications.
- **Rope** – For increased abrasion resistance and strength.
- **Cable** – Ideal for high heat or leading edge environments.
- **Specialty** – Coated webbing for protection against grease, oil, or other contaminants.
- **Aramid** – Webbing for fire, welding, or arc flash conditions.

### CONNECTOR

- **Soft Loop** – Chokes the lanyard harness attachment point.
- **Snap Hook** – The most common option for small anchor points.
- **Carabiner** – A twist lock gate alternative to hooks.
- **Scaffolding/Rebar Hook** – Offers a larger gate opening for a variety of structural connections.
- **Tie-Back Hook** – Specially built for applications where a standard anchor or connection is unavailable.



**PRO**

**6' STRETCH INTERNAL ENERGY ABSORBING LANYARD: DUAL LEG, ALU REBAR HOOKS**

**FS596-ALU**

The PRO 6' Stretch Internal Energy Absorbing Lanyard expands reach and range of movement, while reducing tripping, snag or other hazards. Made from specialized hi-vis performance webbing with POY and elasticized yarns to create a lightweight, streamlined solution with dual legs for 100% tie-off.

- Stretches from 4' to 6'
- 1-3/8" elasticized Poly/POY web
- Forged aluminum hooks
- Protective label cover
- Minimum Breaking Strength: 5,000 lbs.
- Weight Capacity ANSI 130-310 lbs.
- ANSI Z359.13-2013, OSHA 1926.502, 1910.140, 1910.66

**Single Leg Option**

Part Number	Description
FS595-ALU	PRO 6' Stretch Internal Energy Absorbing Lanyard: Alu Rebar Hook



**PRO 6' Stretch Internal Energy Absorbing Lanyard:**

Dual Leg, Rebar Hooks

**FS596**

- Stretches from 4' to 6'
- 1-3/8" elasticized Poly/POY web
- Forged steel hooks
- Protective label cover
- Minimum Breaking Strength: 5,000 lbs.
- Weight Capacity ANSI 130-310 lbs.
- ANSI Z359.13-2013, OSHA 1926.502, 1910.140, 1910.66

**Single Leg Option**

Part Number	Description
FS595	PRO 6' Stretch Internal Energy Absorbing Lanyard: Rebar Hook

**PRO 6' Stretch Internal Energy Absorbing Lanyard:**

Dual Leg, O-Ring, Alu Rebar Hooks

**FS66150-ALU**

- Stretches from 4' to 6'
- 1-3/8" elasticized Poly/POY web
- Aluminum hooks
- SRL O-ring connection
- Protective label cover
- Minimum Breaking Strength: 5,000 lbs.
- Weight Capacity ANSI 130-310 lbs.
- ANSI Z359.13-2013, OSHA 1926.502, 1910.140, 1910.66





**PRO 6' Stretch Internal Energy Absorbing Lanyard:**  
Dual Leg, O-Ring, Rebar Hooks

**FS66150**

- Stretches from 4' to 6'
- 1-3/8" elasticized Poly/POY web
- Forged steel hooks
- SRL O-ring connection
- Protective label cover
- Minimum Breaking Strength: 5,000 lbs.
- Weight Capacity ANSI 130-310 lbs.
- ANSI Z359.13-2013, OSHA 1926.502, 1910.140, 1910.66

**Single Leg Option**

Part Number	Description
FS66100	PRO 6' Stretch Internal Energy Absorbing Lanyard: O-Ring, Rebar Hook



**PRO 6' Stretch Internal Energy Absorbing Lanyard:**  
Dual Leg, Snap Hooks

**FS591**

- Stretches from 4' to 6'
- 1-3/8" elasticized Poly/POY web
- Forged steel hooks
- Protective label cover
- Minimum Breaking Strength: 5,000 lbs.
- Weight Capacity ANSI 130-310 lbs.
- ANSI Z359.13-2013, OSHA 1926.502, 1910.140, 1910.66

**Single Leg Option**

Part Number	Description
FS590	PRO 6' Stretch Internal Energy Absorbing Lanyard: Snap Hook



**PRO 6' Stretch Internal Energy Absorbing Lanyard:**  
Dual Leg, Alu Snap Hooks

**FS591-ALU**

- Stretches from 4' to 6'
- 1-3/8" elasticized Poly/POY web
- Forged aluminum hooks
- Protective label cover
- Minimum Breaking Strength: 5,000 lbs.
- Weight Capacity ANSI 130-310 lbs.
- ANSI Z359.13-2013, OSHA 1926.502, 1910.140, 1910.66

**Single Leg Option**

Part Number	Description
FA590-ALU	PRO 6' Stretch Internal Energy Absorbing Lanyard: Alu Snap Hook



**PRO**  
**6' INTERNAL ENERGY ABSORBING LANYARD: DUAL LEG, REBAR HOOKS**

**FS586**

The PRO 6' Internal Energy Absorbing Lanyard is made from specialized high performance webbing with POY at the core to act as deceleration and force management system, creating a lightweight streamlined design with no external energy absorber and dual legs for 100% tie-off.

- 1-3/8" Poly/POY webbing
- Forged steel hooks
- Protective label cover
- Minimum Breaking Strength: 5,000 lbs.
- Weight Capacity ANSI 130-310 lbs.
- ANSI Z359.13-2013, OSHA 1926.502, 1910.140, 1910.66



**PRO 6' Internal Energy Absorbing Lanyard: Rebar Hook**

**FS585**

- 1-3/8" Poly/POY webbing
- Forged steel hooks
- Protective label cover
- Minimum Breaking Strength: 5,000 lbs.
- Weight Capacity ANSI 130-310 lbs.
- ANSI Z359.13-2013, OSHA 1926.502, 1910.140, 1910.66



**PRO 6' Internal Energy Absorbing Lanyard: Dual Leg, Snap Hooks**

**FS581**

- 1-3/8" Poly/POY webbing
- Forged steel hooks
- Protective label cover
- Minimum Breaking Strength: 5,000 lbs.
- Weight Capacity ANSI 130-310 lbs.
- ANSI Z359.13-2013, OSHA 1926.502, 1910.140, 1910.66

**Single Leg Option**

Part Number	Description
FS580	PRO 6' Internal Energy Absorbing Lanyard: Snap Hook

# FALL CLEARANCE - LANYARDS

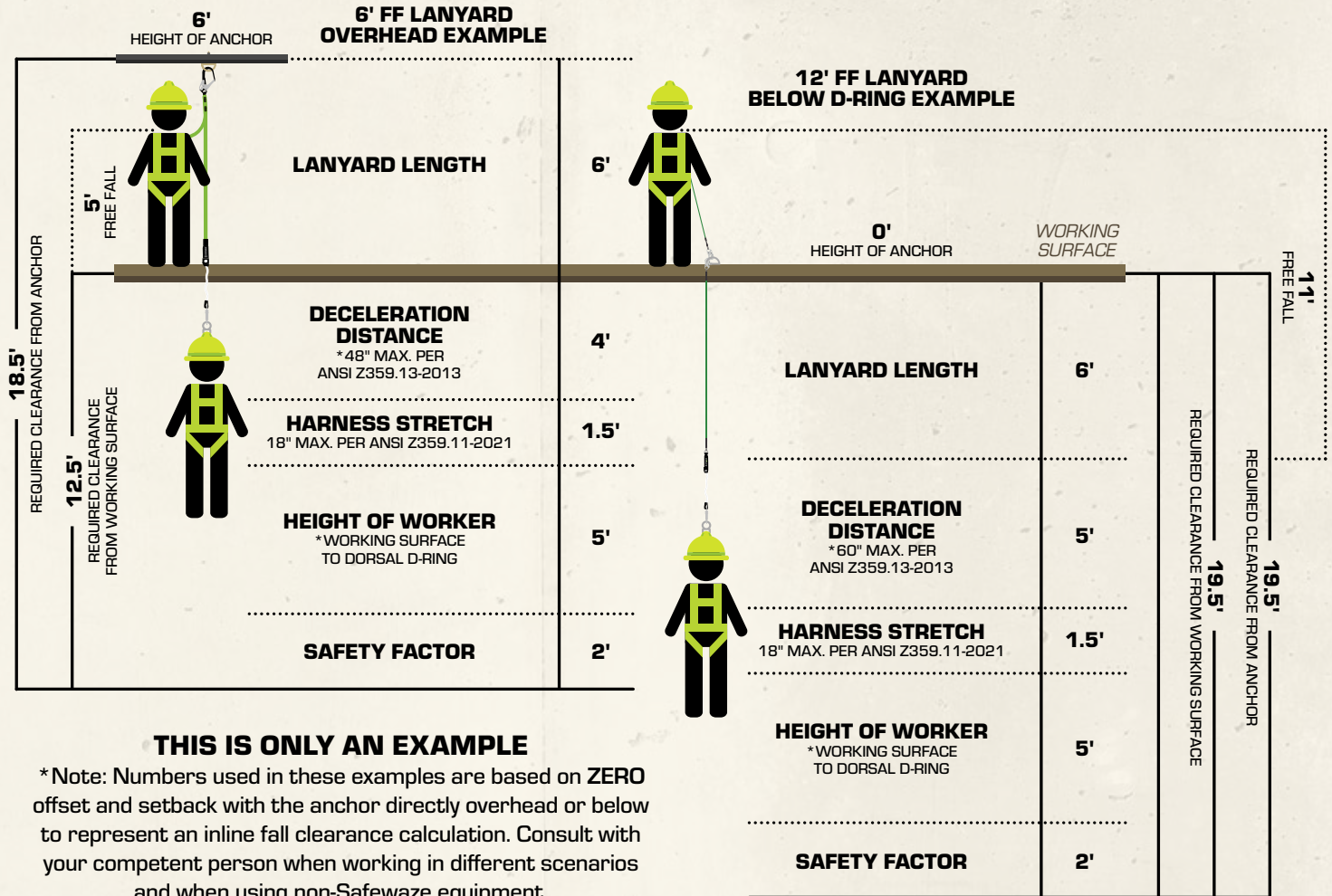

**THIS IS ONLY AN EXAMPLE**

\*Note: Numbers used in these examples are based on ZERO offset and setback with the anchor directly overhead or below to represent an inline fall clearance calculation. Consult with your competent person when working in different scenarios and when using non-Safewaze equipment.

## V-LINE

### V-LINE 6' ENERGY ABSORBING LANYARD: DUAL LEG, REBAR HOOKS

FS88566-E

The V-Line 6' Energy Absorbing Lanyard combines performance with economical value. Built with abrasion resistant webbing, dual legs for 100% tie-off and efficient tear webbing to reduce fall arrest force.

- 1" polyester hi-vis webbing
- Stamped steel hooks
- Durable shock/label cover
- Minimum Breaking Strength: 5,000 lbs.
- Weight Capacity ANSI 130-310 lbs.
- ANSI Z359.13-2013, OSHA 1926.502, 1910.140, 1910.66

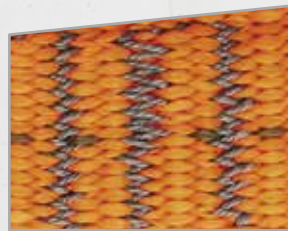

High Performance  
Stitching



Dual Leg



Steel Snap Hook



Steel Rebar Hook



Durable Shock Cover



Hi-Vis Orange  
Webbing



**V-Line 6' Energy Absorbing Lanyard:**  
Rebar Hook  
**FS88565-E**

- 1" polyester hi-vis webbing
- Stamped steel hooks
- Durable shock/label cover
- Minimum Breaking Strength: 5,000 lbs.
- Weight Capacity ANSI 130-310 lbs.
- ANSI Z359.13-2013, OSHA 1926.502, 1910.140, 1910.66



**V-Line 6' Energy Absorbing Lanyard:**  
Dual Leg, Snap Hooks  
**FS88561-E**

- 1" polyester hi-vis webbing
- Stamped steel hooks
- Durable shock/label cover
- Minimum Breaking Strength: 5,000 lbs.
- Weight Capacity ANSI 130-310 lbs.
- ANSI Z359.13-2013, OSHA 1926.502, 1910.140, 1910.66

**Single Leg Option**

Part Number	Description
FS88560-E	V-Line 6' Energy Absorbing Lanyard: Snap Hook



**V-Line 3' Energy Absorbing Lanyard:**  
Snap Hook  
**FS88560-E3**

- 1" polyester hi-vis webbing
- Stamped steel hooks
- Durable shock/label cover
- Minimum Breaking Strength: 5,000 lbs.
- Weight Capacity ANSI 130-310 lbs.
- ANSI Z359.13-2013, OSHA 1926.502, 1910.140, 1910.66

**4' Option with Rebar Hooks**

PART NUMBER	DESCRIPTION
FS88566-4	V-Line 4' Energy Absorbing Lanyard: Dual Leg, Rebar Hooks



## V-LINE

### V-LINE 6' STRETCH INTERNAL ENERGY ABSORBING LANYARD: DUAL LEG, REBAR HOOKS

FS88596

The V-Line 6' Stretch Internal Energy Absorbing Lanyard is an economical low profile, elastic solution designed to expand reach and range of movement, while reducing tripping, snag or other hazards. Built with abrasion resistant hi-vis orange webbing and dual legs for 100% tie-off.

- Stretches from 4' to 6'
- 1-3/8" polyester webbing
- Stamped steel hooks
- Protective label cover
- Minimum Breaking Strength: 5,000 lbs.
- Weight Capacity ANSI 130-310 lbs.
- ANSI Z359.13-2013, OSHA 1926.502, 1910.140, 1910.66



#### V-Line 6' Stretch Internal Energy Absorbing Lanyard:

Rebar Hook

FS88595

- Stretches from 4' to 6'
- 1-3/8" polyester webbing
- Stamped steel hooks
- Protective label cover
- Minimum Breaking Strength: 5,000 lbs.
- Weight Capacity ANSI 130-310 lbs.
- ANSI Z359.13-2013, OSHA 1926.502, 1910.140, 1910.66



#### V-Line 6' Stretch Internal Energy Absorbing Lanyard:

Dual Leg, Snap Hooks

FS88591

- Stretches from 4' to 6'
- 1-3/8" polyester webbing
- Stamped steel hooks
- Protective label cover
- Minimum Breaking Strength: 5,000 lbs.
- Weight Capacity ANSI 130-310 lbs.
- ANSI Z359.13-2013, OSHA 1926.502, 1910.140, 1910.66

#### Single Leg Option

PART NUMBER	DESCRIPTION
FS88590	V-Line 6' Stretch Internal Energy Absorbing Lanyard: Snap Hook



## V-LINE V-LINE 6' INTERNAL ENERGY ABSORBING LANYARD: DUAL LEG, REBAR HOOKS

FS88586

The V-Line 6' Internal Energy Absorbing Lanyard is an economic one-piece solution. Built with durable webbing and integral POY energy absorber plus dual legs for 100% tie-off.

- 1-3/8" polyester tubular webbing
- Stamped steel hooks
- Protective label cover
- Minimum Breaking Strength: 5,000 lbs.
- Weight Capacity ANSI 130-310 lbs.
- ANSI Z359.13-2013, OSHA 1926.502, 1910.140, 1910.66

### Single Leg Option

Part Number	Description
FS88585	V-Line 6' Internal Energy Absorbing Lanyard: Rebar Hook



## V-Line 6' Internal Energy Absorbing Lanyard:

Dual Leg, Snap Hooks

FS88581

- 1-3/8" polyester tubular webbing
- Stamped steel hooks
- Protective label cover
- Minimum Breaking Strength: 5,000 lbs.
- Weight Capacity ANSI 130-310 lbs.
- ANSI Z359.13-2013, OSHA 1926.502, 1910.140, 1910.66

### Single Leg Option

Part Number	Description
FS88580	V-Line 6' Internal Energy Absorbing Lanyard: Snap Hook

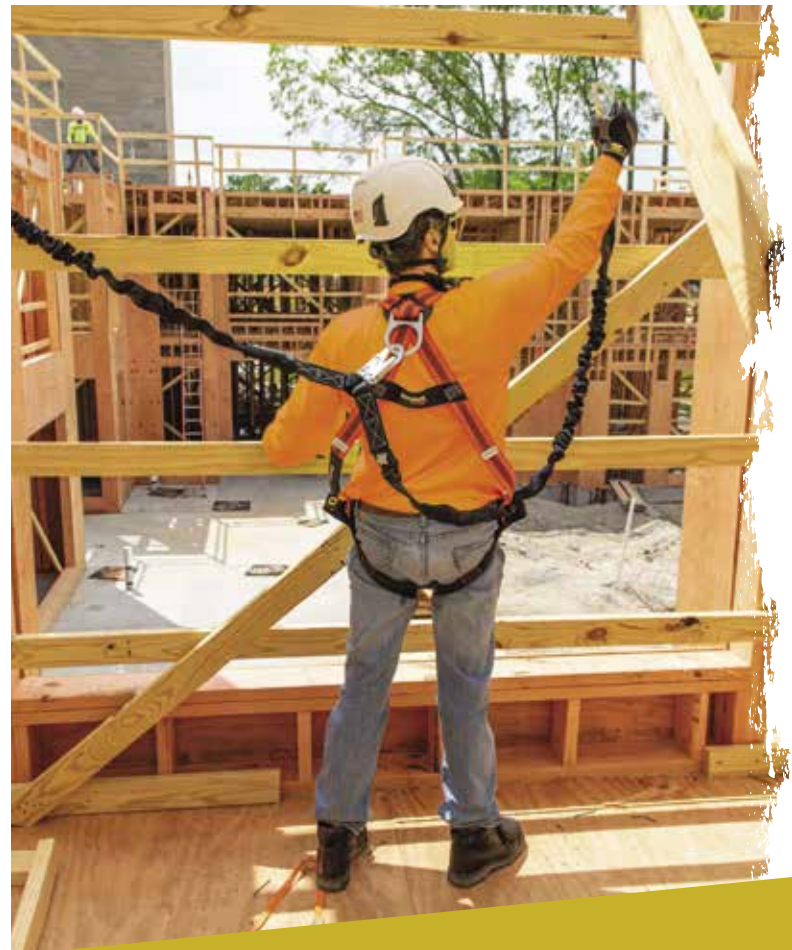



## LEADING EDGE 6' ENERGY ABSORBING LANYARD: DUAL LEG, ALU SWIVEL REBAR

019-2016

The Leading Edge 6' Energy Absorbing Lanyard provides edge protection to users of any weight class, working at both 6' and 12' free fall heights. This versatile all-in-one solution is built with aircraft grade steel cable, dual legs for 100% tie-off and specially engineered tear webbing to reduce fall arrest force.

- 12' free fall lanyard
- 6' free fall lanyard
- 1/4" hi-vis coated green cable
- Forged aluminum hooks
- Swivel rebar hooks
- Ballistic shock/label cover
- Minimum Breaking Strength: 5,000 lbs.
- Weight Capacity ANSI 130-310 lbs., OSHA 420 lbs.
- ANSI Z359.13-2013, OSHA 1926.502, 1910.140, 1910.66

**THE CLOSEST YOU CAN GET TO AN ALL-PURPOSE LANYARD.**



Hi-Vis Coated Green Cable



Swivel Connection



Ballistic Shock Cover



### Swivel Snap Hook Option

Part Number	Description
019-2015	Leading Edge 6' Energy Absorbing Lanyard: Alu Swivel Snap Hooks





**Leading Edge 6' Energy Absorbing Lanyard:**

Dual Leg, Rebar Hooks

**019-2014**

- 12' free fall lanyard
- 6' free fall lanyard
- 1/4" hi-vis coated green cable
- Forged steel hooks
- Ballistic shock/label cover
- Minimum Breaking Strength: 5,000 lbs.
- Weight Capacity ANSI 130-310 lbs., OSHA 420 lbs.
- ANSI Z359.13-2013, OSHA 1926.502, 1910.140, 1910.66

**Single Leg Option**

Part Number	Description
019-2013	Leading Edge 6' Energy Absorbing Lanyard: Rebar Hook



**Leading Edge 6' Energy Absorbing Lanyard:**

Dual Leg, Snap Hooks

**019-2012**

- 12' free fall lanyard
- 6' free fall lanyard
- 1/4" hi-vis coated green cable
- Forged steel hooks
- Ballistic shock/label cover
- Minimum Breaking Strength: 5,000 lbs.
- Weight Capacity ANSI 130-310 lbs., OSHA 420 lbs.
- ANSI Z359.13-2013, OSHA 1926.502, 1910.140, 1910.66

**Single Leg Option**

Part Number	Description
019-2011	Leading Edge 6' Energy Absorbing Lanyard: Snap Hook



**Leading Edge 6' Energy Absorbing Lanyard:**

D-Ring, Dual Leg, Snap Hooks

**021-2062**

- 12' free fall lanyard
- 6' free fall lanyard
- 1/4" hi-vis coated green cable
- Forged steel hooks
- Ballistic shock/label cover
- Additional D-ring above shock pack
- Minimum Breaking Strength: 5,000 lbs.
- Weight Capacity ANSI 130-310 lbs., OSHA 420 lbs.
- ANSI Z359.13-2013, OSHA 1926.502, 1910.140, 1910.66



## ARC FLASH 6' ENERGY ABSORBING LANYARD: ARAMID, DUAL LEG, DIELECTRIC SNAP HOOKS

020-2040

The Arc Flash 6' Energy Absorbing Lanyard is a specialized connection solution providing safe, secure work in arc event rated areas. Built with dual legs for 100% tie-off plus superior flame and heat resistant aramid yarns.

- 1-3/4" aramid webbing
- Dielectric hooks
- Nomex® shock/label cover
- 40Cal/750F rated
- Minimum Breaking Strength: 5,000 lbs.
- Weight Capacity ANSI 130-310 lbs.
- ANSI Z359.13-2013, OSHA 1926.502, 1910.140, 1910.66, ASTM F887



### Arc Flash 6' Energy Absorbing Lanyard: Aramid, Dual Leg, Alu Rebar Hooks

020-2041

- 1-3/4" aramid webbing
- Forged aluminum hooks
- Nomex® shock/label cover
- 40Cal/750F rated
- Minimum Breaking Strength: 5,000 lbs.
- Weight Capacity ANSI 130-310 lbs.
- ANSI Z359.13-2013, OSHA 1926.502, 1910.140, 1910.66, ASTM F887



### Arc Flash 6' Energy Absorbing Lanyard: Aramid, Dual Leg, Rebar Hooks

020-2042

- 1-3/4" aramid webbing
- Forged steel hooks
- Nomex® shock/label cover
- 40Cal/750F rated
- Minimum Breaking Strength: 5,000 lbs.
- Weight Capacity ANSI 130-310 lbs.
- ANSI Z359.13-2013, OSHA 1926.502, 1910.140, 1910.66, ASTM F887



**Arc Flash 6' Energy Absorbing Lanyard:**  
 Aramid, Dual Leg, Alu Snap Hooks  
**020-2043**

- 1-3/4" aramid webbing
- Forged aluminum hooks
- Nomex® shock/label cover
- 40Cal/750F rated
- Minimum Breaking Strength: 5,000 lbs.
- Weight Capacity ANSI 130-310 lbs.
- ANSI Z359.13-2013, OSHA 1926.502, 1910.140, 1910.66, ASTM F887



**Arc Flash 6' Energy Absorbing Lanyard:**  
 Aramid, Dual Leg, Snap Hooks  
**020-2044**

- 1-3/4" aramid webbing
- Forged steel hooks
- Nomex® shock/label cover
- 40Cal/750F rated
- Minimum Breaking Strength: 5,000 lbs.
- Weight Capacity ANSI 130-310 lbs.
- ANSI Z359.13-2013, OSHA 1926.502, 1910.140, 1910.66, ASTM F887

**Single Leg Option**

Part Number	Description
020-2045	Arc Flash 6' Energy Absorbing Lanyard: Aramid, Snap Hook



**Arc Flash 6' Energy Absorbing Lanyard:**  
 Aramid, Dielectric Snap Hook, Soft Loop  
**022-2087**

- 1-3/4" aramid webbing
- Dielectric hook
- Aramid soft loop
- Nomex® shock/label cover
- 40Cal/750F rated
- Minimum Breaking Strength: 5,000 lbs.
- Weight Capacity ANSI 130-310 lbs.
- ANSI Z359.13-2013, OSHA 1926.502, 1910.140, 1910.66, ASTM F887

**Forged Steel Snap Option**

Part Number	Description
020-2046	Arc Flash 6' Energy Absorbing Lanyard: Aramid, Snap Hook, Soft Loop





## ARC FLASH 6' ENERGY ABSORBING LANYARD: DUAL LEG, DIELECTRIC SNAP HOOKS

SW561-AF-DE

The Arc Flash 6' Energy Absorbing Lanyard is a specialized connection solution providing safe, secure work in arc event rated areas. Built with dual legs for 100% tie-off plus Mil-Spec flame and heat resistant nylon webbing.

- 1" nylon webbing
- Dielectric hooks
- Nomex® shock/label cover
- 40Cal/550F rated
- Minimum Breaking Strength: 5,000 lbs.
- Weight Capacity ANSI 130-310 lbs.
- ANSI Z359.13-2013, OSHA 1926.502, 1910.140, 1910.66, ASTM F887

### Single Leg Option

Part Number	Description
SW560-AF-DE	Arc Flash 6' Energy Absorbing Lanyard: Dielectric Snap Hook



### Arc Flash 6' Energy Absorbing Lanyard: Dielectric Snap Hook, Soft Loop

SW560-AF-DE-SE

- 1" nylon webbing
- Dielectric hook
- Soft loop
- Nomex® shock/label cover
- 40Cal/550F rated
- Minimum Breaking Strength: 5,000 lbs.
- Weight Capacity ANSI 130-310 lbs.
- ANSI Z359.13-2013, OSHA 1926.502, 1910.140, 1910.66, ASTM F887

### Snap Hook Option

Part Number	Description
FS560-AF-SE	Arc Flash 6' Energy Absorbing Lanyard: Snap Hook, Soft Loop



### Arc Flash 4'-6' Adjustable Energy Absorbing Lanyard: Snap Hook

FS560-AF-AJ

- Adjustable 4'-6'
- 1" nylon webbing
- Forged steel hooks
- Nomex® shock/label cover
- 40Cal/550F rated
- Minimum Breaking Strength: 5,000 lbs.
- Weight Capacity ANSI 130-310 lbs.
- ANSI Z359.13-2013, OSHA 1926.502, 1910.140, 1910.66, ASTM F887

### Arc Flash 6' EA Lanyard

Part Number	Description
FS560-AF	Arc Flash 6' Energy Absorbing Lanyard: Snap Hook



## ARC FLASH 6' INTERNAL ENERGY ABSORBING LANYARD: ARAMID, DUAL LEG, SNAP HOOKS

023-2101

The Arc Flash 6' Internal Energy Absorbing Lanyard combines the specialization of safety in arc event rated areas with high performance webbing that acts as the force management system for a streamlined design with no external energy absorber.

- 1-3/8" tubular aramid webbing
- Forged steel hooks
- Nomex® label cover
- 40Cal/750F rated
- Minimum Breaking Strength: 5,000 lbs.
- Weight Capacity ANSI 130-310 lbs.
- ANSI Z359.13-2013, OSHA 1926.502, 1910.140, 1910.66, ASTM F887

### Single Leg Option

Part Number	Description
023-2107	Arc Flash 6' Internal Energy Absorbing Lanyard: Aramid, Snap Hook



## Arc Flash 6' Internal Energy Absorbing Lanyard:

Aramid, Dual Leg, Rebar Hooks

023-2102

- 1-3/8" tubular aramid webbing
- Forged steel hooks
- Nomex® label cover
- 40Cal/750F rated
- Minimum Breaking Strength: 5,000 lbs.
- Weight Capacity ANSI 130-310 lbs.
- ANSI Z359.13-2013, OSHA 1926.502, 1910.140, 1910.66, ASTM F887

### Single Leg Option

Part Number	Description
023-2108	Arc Flash 6' Internal Energy Absorbing Lanyard: Aramid, Rebar Hook



## Arc Flash 6' Internal Energy Absorbing Lanyard:

Aramid, Dual Leg, Alu Snap Hooks

023-2103

- 1-3/8" tubular aramid webbing
- Aluminum hooks
- Nomex® label cover
- 40Cal/750F rated
- Minimum Breaking Strength: 5,000 lbs.
- Weight Capacity ANSI 130-310 lbs.
- ANSI Z359.13-2013, OSHA 1926.502, 1910.140, 1910.66, ASTM F887

### Single Leg Option

Part Number	Description
023-2109	Arc Flash 6' Internal Energy Absorbing Lanyard: Aramid, Alu Snap Hook



**Arc Flash 6' Internal Energy Absorbing Lanyard:**  
Aramid, Dual Leg, Alu Rebar Hooks

**023-2104**

- 1-3/8" tubular aramid webbing
- Aluminum hooks
- Nomex® label cover
- 40Cal/750F rated
- Minimum Breaking Strength: 5,000 lbs.
- Weight Capacity ANSI 130-310 lbs.
- ANSI Z359.13-2013, OSHA 1926.502, 1910.140, 1910.66, ASTM F887

**Single Leg Option**

Part Number	Description
023-2110	Arc Flash 6' Internal Energy Absorbing Lanyard: Aramid, Alu Rebar Hook



**Arc Flash 6' Internal Energy Absorbing Lanyard:**  
Aramid, Dual Leg, Dielectric Snap Hooks

**023-2105**

- 1-3/8" tubular aramid webbing
- Dielectric hooks
- Nomex® label cover
- 40Cal/750F rated
- Minimum Breaking Strength: 5,000 lbs.
- Weight Capacity ANSI 130-310 lbs.
- ANSI Z359.13-2013, OSHA 1926.502, 1910.140, 1910.66, ASTM F887

**Single Leg Option**

Part Number	Description
023-2111	Arc Flash 6' Internal Energy Absorbing Lanyard: Aramid, Dielectric Snap Hook



## WELDING 6' ENERGY ABSORBING LANYARD: DUAL LEG, SNAP HOOKS

**FS77330-FR-DL**

The Welding 6' Energy Absorbing Lanyard protects workers exposed to flame, fire or other welding processes. Equipped with dual legs for 100% tie-off and aramid webbing.

- 1-3/4" aramid webbing
- Forged steel hooks
- Nomex® shock/label cover
- 40Cal/700F rated
- Minimum Breaking Strength: 5,000 lbs.
- Weight Capacity ANSI 130-310 lbs.
- ANSI Z359.13-2013, OSHA 1926.502, 1910.140, 1910.66

### Single Leg Option

Part Number	Description
FS77330-FR	Welding 6' Energy Absorbing Lanyard: Snap Hook



## Welding 6' Energy Absorbing Lanyard: Dual Leg, Rebar Hooks

**FS77435-WE-DL**

- 1-3/4" dual layer aramid webbing
- Forged steel hooks
- Nomex® shock/label cover
- 40Cal/700F rated
- Minimum Breaking Strength: 5,000 lbs.
- Weight Capacity ANSI 130-310 lbs.
- ANSI Z359.13-2013, OSHA 1926.502, 1910.140, 1910.66

### Single Leg Option

Part Number	Description
FS77435-WE	Welding 6' Energy Absorbing Lanyard: Rebar Hook



## Welding 6' Energy Absorbing Lanyard: Dual Leg, Snap Hooks

**FS77430-WE-DL**

- 1-3/4" dual layer aramid webbing
- Forged steel hooks
- Nomex® shock/label cover
- 40Cal/700F rated
- Minimum Breaking Strength: 5,000 lbs.
- Weight Capacity ANSI 130-310 lbs.
- ANSI Z359.13-2013, OSHA 1926.502, 1910.140, 1910.66

### Single Leg Option

Part Number	Description
FS77430-WE	Welding 6' Energy Absorbing Lanyard: Snap Hook



## HEAVYWEIGHT 6' ENERGY ABSORBING LANYARD: DUAL LEG, ALU REBAR HOOKS

FS88666-HW-ALU

The Heavyweight 6' Energy Absorbing Lanyard is designed especially for workers from 310 lbs. to 420 lbs. Built with high-strength webbing, dual legs for 100% tie-off and efficient tear webbing to reduce fall arrest force.

- 1" high strength webbing
- Forged aluminum hooks
- Ballistic shock/label cover
- Minimum Breaking Strength: 5,000 lbs.
- Weight Capacity ANSI 130-310 lbs., OSHA 420 lbs.
- OSHA 1926.502, 1910.140, 1910.66



### Heavyweight 6' Energy Absorbing Lanyard: Dual Leg, Rebar Hooks

FS88666-HW

- 1" high strength webbing
- Forged steel hooks
- Ballistic shock/label cover
- Minimum Breaking Strength: 5,000 lbs.
- Weight Capacity ANSI 130-310 lbs., OSHA 420 lbs.
- OSHA 1926.502, 1910.140, 1910.66

#### Single Leg Option

Part Number	Description
FS88665-HW	Heavyweight 6' Energy Absorbing Lanyard: Rebar Hook



### Heavyweight 6' Energy Absorbing Lanyard: Dual Leg, Snap Hooks

FS88661-HW

- 1" high strength webbing
- Forged steel hooks
- Ballistic shock/label cover
- Minimum Breaking Strength: 5,000 lbs.
- Weight Capacity ANSI 130-310 lbs., OSHA 420 lbs.
- OSHA 1926.502, 1910.140, 1910.66

#### Single Leg Option

Part Number	Description
FS88660-HW	Heavyweight 6' Energy Absorbing Lanyard: Snap Hook



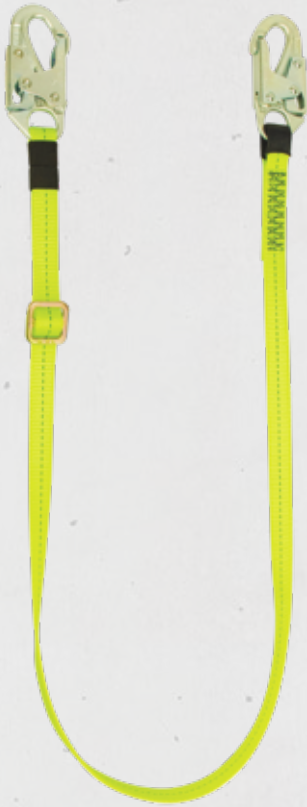

## 6' ADJUSTABLE WEB RESTRAINT LANYARD

FS33310

The 6' Adjustable Web Restraint Lanyard is the ideal non-energy absorbing connector for work positioning or restraint applications with convenient adjustability for just the right fit.

- Adjustable 4'-6'
- 1" hi-vis green webbing
- Forged steel hooks
- Minimum Breaking Strength: 5,000 lbs.
- Weight Capacity ANSI 130-310 lbs., OSHA 420 lbs.
- ANSI Z359.3-2019, OSHA 1926.502, 1910.140, 1910.66

### Web Restraint Option (Fixed)

Part Number	Description
FS88860	6' Web Restraint Lanyard



## 6' Rope Restraint Lanyard

FS33210

- 5/8" polyester rope
- Forged steel hooks
- Positioning or restraint
- Minimum Breaking Strength: 5,000 lbs.
- Weight Capacity ANSI 130-310 lbs., OSHA 420 lbs.
- ANSI Z359.3-2019, OSHA 1926.502, 1910.140, 1910.66



## 20" Web Restraint Lanyard:

Alu Snap Hook, Alu Rebar Hook

021-2075

- 1-3/4" hi-vis green webbing
- Aluminum hooks
- Minimum Breaking Strength: 5,000 lbs.
- Weight Capacity ANSI 130-310 lbs., OSHA 420 lbs.
- ANSI Z359.3-2019, OSHA 1926.502, 1910.140, 1910.66

## 6.5' ROPE POSITIONING ASSEMBLY: ROPE ADJUSTER, CARABINERS

021-2064

The 6.5' Rope Positioning Assembly: Rope Adjuster, Carabiners is a complete non-energy absorbing solution for positioning or restraint. Rugged rope with added wear sleeve increases product life and built-in adjuster improves mobility.

- Durable 7/16" Kernmantle rope
- Easy positioning rope adjuster
- Protective nylon wear sleeve
- Steel carabiners
- Minimum Breaking Strength: 5,000 lbs.
- Weight Capacity ANSI 130-310 lbs., OSHA 420 lbs.
- ANSI Z359.3-2019, OSHA 1926.502, 1910.140, 1910.66



Kernmantle Rope



Protective Sleeve



Rope Adjuster





**6.5' Rope Positioning Assembly:**  
Rope Adjuster, Alu Carabiners  
**021-2065**

- Durable 7/16" Kernmantle rope
- Easy positioning rope adjuster
- Protective nylon wear sleeve
- Aluminum carabiners
- Minimum Breaking Strength: 5,000 lbs.
- Weight Capacity ANSI 130-310 lbs., OSHA 420 lbs.
- ANSI Z359.3-2019, OSHA 1926.502, 1910.140, 1910.66



**6.5' Rope Positioning Assembly:**  
Rope Adjuster, No Connectors  
**021-2066**

- Durable 7/16" Kernmantle rope
- Easy positioning rope adjuster
- Protective nylon wear sleeve
- Connectors not included
- Minimum Breaking Strength: 5,000 lbs.
- Weight Capacity ANSI 130-310 lbs., OSHA 420 lbs.
- ANSI Z359.3-2019, OSHA 1926.502, 1910.140, 1910.66



**6' Rope Positioning Assembly:**  
Rope Ascender, Snap Hook  
**FS33200**

- 5/8" polyester rope
- Forged steel hook
- Steel rope grab
- Rope protector
- Positioning or restraint
- Breaking Strength: 5,000 lbs. minimum
- Weight Capacity ANSI 130-310 lbs., OSHA 420 lbs.
- ANSI Z359.3-2019, OSHA 1926.502, 1910.140, 1910.66





**26" Chain Assembly:**  
Adjustable, Non-Swivel Rebar Hook  
**FS060-E**

- Adjustable, durable chain
- Stamped steel hooks
- Minimum Breaking Strength: 5,000 lbs.
- Weight Capacity ANSI 130-310 lbs., OSHA 420 lbs.
- OSHA 1926.502, 1910.140, 1910.66

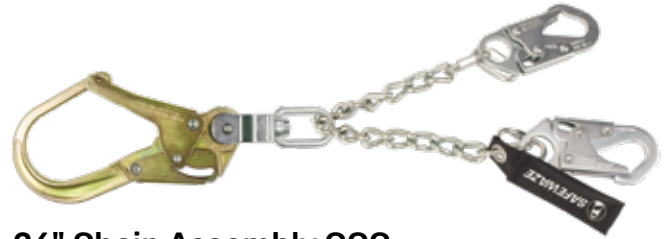

**26" Chain Assembly GCC:**  
Adjustable, Gates Form Swivel Rebar Hook  
**FS060-GCC**

- Adjustable, durable chain
- Forged steel hooks
- Swivel rebar hook fits gates form
- Minimum Breaking Strength: 5,000 lbs.
- Weight Capacity ANSI 130-310 lbs., OSHA 420 lbs.
- OSHA 1926.502, 1910.140, 1910.66

**Standard Rebar Hook Option**

Part Number	Description
FS060	26" Chain Assembly: Adjustable, Swivel Rebar Hook

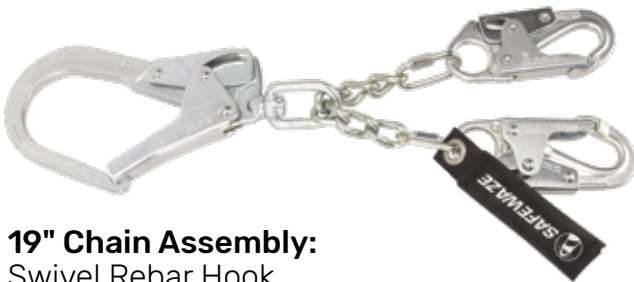

**19" Chain Assembly:**  
Swivel Rebar Hook  
**FS061**

- Durable chain
- Forged steel hooks
- Swivel rebar hook
- Minimum Breaking Strength: 5,000 lbs.
- Weight Capacity ANSI 130-310 lbs., OSHA 420 lbs.
- OSHA 1926.502, 1910.140, 1910.66



**18" Web Assembly:**  
Swivel Rebar Hook  
**FS060-WEB**

- Polyester webbing
- Forged steel hooks
- Minimum Breaking Strength: 5,000 lbs.
- Weight Capacity ANSI 130-310 lbs., OSHA 420 lbs.
- ANSI Z359.3-2019, OSHA 1926.502, 1910.140, 1910.66

**Snap Hook Option**

Part Number	Description
FS060-WEB-SH	18" Web Assembly: Snap Hook



## 18" D-RING EXTENDER: REBAR HOOK, D-RING

FS814

The 18" D-Ring Extender provides additional length between the harness and another component of the fall arrest system for quick, easy connection.

- 18" fixed length
- Forged steel hardware
- Minimum Breaking Strength: 5,000 lbs.
- Weight Capacity ANSI 130-310 lbs., OSHA 420 lbs.
- ANSI Z359.11-2021, OSHA 1926.502, 1910.140, 1910.66



### 18" D-Ring Extender: Snap Hook, D-Ring

FS813

- 18" fixed length
- Forged steel hardware
- Minimum Breaking Strength: 5,000 lbs.
- Weight Capacity ANSI 130-310 lbs., OSHA 420 lbs.
- ANSI Z359.11-2021, OSHA 1926.502, 1910.140, 1910.66



### 18" D-Ring Extender: Soft Loop, D-Ring

FS813-LOOP

- 18" fixed length
- Soft choke loop
- Forged steel D-ring
- Minimum Breaking Strength: 5,000 lbs.
- Weight Capacity ANSI 130-310 lbs., OSHA 420 lbs.
- ANSI Z359.11-2021, OSHA 1926.502, 1910.140, 1910.66

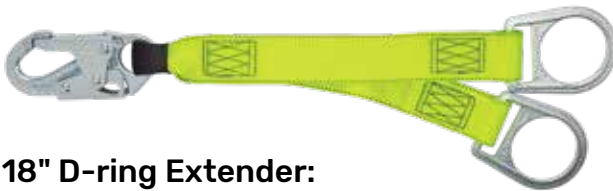

### 18" D-ring Extender: Snap Hook, 2 D-Rings

FS813-2D

- 18" fixed length
- Forged steel hardware
- Minimum Breaking Strength: 5,000 lbs.
- Weight Capacity ANSI 130-310 lbs., OSHA 420 lbs.
- ANSI Z359.11-2021, OSHA 1926.502, 1910.140, 1910.66

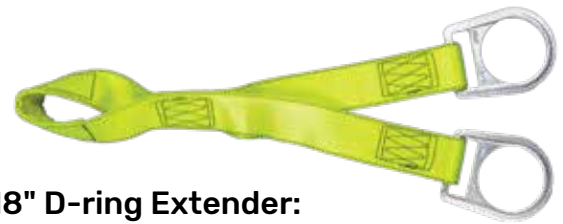

### 18" D-ring Extender: Soft Loop, 2 D-Rings

019-2008

- 18" fixed length
- Soft choke loop
- Forged steel D-rings
- Minimum Breaking Strength: 5,000 lbs.
- Weight Capacity ANSI 130-310 lbs., OSHA 420 lbs.
- ANSI Z359.11-2021, OSHA 1926.502, 1910.140, 1910.66



**18" Energy Absorber:**  
Snap Hook, D-Ring  
**FS8800SP-D**

- 18" fixed length
- Forged steel hardware
- Durable shock/label cover
- Minimum Breaking Strength: 5,000 lbs.
- Weight Capacity ANSI 130-310 lbs., OSHA 420 lbs.
- ANSI Z359.13-2013, OSHA 1926.502, 1910.140, 1910.66



**20" Energy Absorber:**  
Soft Loop, Snap Hook  
**FS8800SP-L**

- 20" fixed length
- Soft choke loop
- Forged steel hook
- Durable shock/label cover
- Minimum Breaking Strength: 5,000 lbs.
- Weight Capacity ANSI 130-310 lbs., OSHA 420 lbs.
- ANSI Z359.13-2013, OSHA 1926.502, 1910.140, 1910.66



**18" Arc Flash D-Ring Extender:**  
Soft Loop, D-Ring  
**022-2081**

- 18" fixed length
- Aramid soft choke loop
- Forged steel D-ring
- Nomex label cover
- 40Cal rated
- Minimum Breaking Strength: 5,000 lbs.
- Weight Capacity ANSI 130-310 lbs., OSHA 420 lbs.
- ANSI Z359.11-2021, OSHA 1926.502, 1910.140, 1910.66, ASTM F887



**12" Arc Flash D-Ring Extender:**  
Soft Loop, D-Ring  
**022-2080**

- 12" length
- Aramid soft choke loop
- Forged steel D-ring
- Nomex label cover
- 40Cal rated
- Minimum Breaking Strength: 5,000 lbs.
- Weight Capacity ANSI 130-310 lbs., OSHA 420 lbs.
- ANSI Z359.11-2021, OSHA 1926.502, 1910.140, 1910.66, ASTM F887



# INTERESTED IN THE NEWEST RELEASES FOR LANYARDS?

Scan this code to view them now!





## SELF-RETRACTING LIFELINES

You can have it all with our self-retracting lifelines: enhanced mobility, increased durability and continued dependability. From lightweight or heavy duty to leading edge or arc flash, with advanced options such as a revolutionary internal braking system, our SRLs are proven to go the distance.





## NORTHSTAR

Our most advanced offering in the SRL category. Engineered for enhanced productivity with superior durability, features and functionality including options for leading edge and coastal environments.



## NORTHSTAR CLASSIC

The dependable workhorse with an outstanding track record of reliability. Built to last, this line provides an economical solution without compromising performance, convenience or safety.



## LATITUDE EDGE

The personal SRL solution for leading edge applications. These units are specifically designed for foot level tie off and allow the worker-at-height to access locations other web or non-LE units can't take them.



## LATITUDE PRO

The performance driven personal SRL series that utilizes a revolutionary internal brake system to reduce work zone obstructions. Built to provide the end user with the certainty and confidence they need to work in a wide variety of jobsite conditions including arc flash and tie back options.



## LATITUDE

The extremely compact and lightweight personal SRL with a design that is virtually unnoticeable on the body. This is the simple and economical replacement to a traditional lanyard offering versatility and additional safety.



## LATITUDE HD

The versatile overhead and personal SRL series. Built with a durable aluminum housing and internal brake system. When the job calls for "heavy duty" these are the units you can count on.

# NORTHSTAR

The Northstar Leading Edge Cable SRLs are engineered for durability and longevity. Built with semi-sealed internal components to limit dirt and debris, lightweight housing with ergonomic handle and simplified service system. These dependable SRLs improve work performance while reducing down time.



- Durable glass-filled nylon housing
- Semi-sealed mainspring and pawl assembly
- Oscillating, double-locking, anti-ratcheting pawls
- 360/180° attachment point swivels for full range of motion
- LI hook shows when SRL has arrested a fall
- RFID equipped for easy asset tracking
- Class 2 SRL for use above or below dorsal D-ring
- Weight Capacity ANSI 130-310 lbs., OSHA 420 lbs.
- ANSI Z359.14-2021, OSHA 1910.140, 1910.66
- All components are Z359.12 compliant



360/180° Attachment Point



Load Indicating Swivel Snap Hook



Innovative Shock Pack



RFID Equipped



Semi-Sealed Construction



Retraction Limiter

### Northstar Leading Edge Cable Options

	20 ft.	30 ft.	50 ft.
LI Swivel Snap Hook	022-5300	022-5301	022-5302



**Northstar Coastal 20' LE SS Cable SRL**  
**022-5292**

- All the same features as the Northstar Leading Edge SRL
- Corrosion resistant stainless steel and aluminum components
- Ideal for extreme environments with salt water or high humidity
- Class 2 SRL for use above or below dorsal D-ring
- Weight Capacity ANSI 130-310 lbs., OSHA 420 lbs.
- ANSI Z359.14-2021, OSHA 1910.140, 1910.66
- All components are Z359.12 compliant

**Northstar Coastal LE SS Cable Options**

	20 ft.	30 ft.	50 ft.
Aluminum Carabiner	022-5292	022-5293	022-5294





## NORTHSTAR CLASSIC

The Northstar Classic SRLs are designed to last with specialized impact resistant housing and non-corrosive components. This durable SRL offers swivel mobility and fast-acting braking for low clearance.

- Swivel attachment point offers wide range of motion
- High strength polymer housing resists impact
- Braking system activates quickly to arrest fall
- Class 1 SRL for use at or above dorsal D-ring
- Weight Capacity ANSI 130-310 lbs., OSHA 420 lbs.
- ANSI Z359.14-2021, OSHA 1910.140, 1910.66, 1926.502
- All components are Z359.12 compliant



**Northstar Classic  
20' Web SRL  
FS-FSP1420-W**



**Northstar Classic  
30' Web SRL  
FS-EX1530-W**



**Northstar Classic  
50' Web SRL  
FS-EX1550-W**

**Northstar Classic Web Options**

	20 ft.	30 ft.	50 ft.
<b>1" UHMPE HEAVY DUTY WEBBING WITH FALL INDICATOR</b>			
Snap Hook	FS-FSP1420-W	FS-EX1530-W	FS-EX1550-W



**Northstar Classic  
15' Cable SRL**  
**FS-FSP1215-G**



**Northstar Classic  
20' Cable SRL**  
**FS-FSP1220-G**



**Northstar Classic  
30' Cable SRL**  
**FS-FSP1230-G**



**Northstar Classic  
50' Cable SRL**  
**FS-FSP1250-G**



**Northstar Classic  
65' Cable SRL**  
**FS-FSP1265-G**



**Northstar Classic  
80' Cable SRL**  
**FS-EX1080-G**



**Northstar Classic  
100' Cable SRL**  
**FS-EX10-100-G**

**Northstar Classic Cable Options**

	15 ft.	20 ft.	30 ft.	50 ft.	65 ft.	80 ft.	100 ft.
<b>3/16" GALVANIZED STEEL CABLE</b>							
<b>LI Swivel Snap Hook</b>	FS-FSP1215-G	FS-FSP1220-G	FS-FSP1230-G	FS-FSP1250-G	FS-FSP1265-G	FS-EX1080-G	FS-EX10-100-G



**Northstar Classic LE 20' Cable SRL  
FS-FSP9020**

- External energy absorber for leading edge use
- Swivel attachment point offers wide range of motion
- High strength polymer housing resists impact
- Braking system activates quickly to arrest fall
- Class 2 SRL for use above or below dorsal D-ring
- Weight Capacity ANSI 130-310 lbs., OSHA 420 lbs.
- ANSI Z359.14-2021, OSHA 1910.140, 1910.66
- All components are Z359.12 compliant

**Northstar Classic Leading Edge Cable Options**

	20 ft.	30 ft.	50 ft.
<b>3/16" GALVANIZED STEEL CABLE</b>			
Aluminum Carabiner	FS-FSP9020	FS-FSP9030	FS-FSP9050

**LEADING EDGE SRL PRECAUTIONS**

- 1 The angle of redirection allowed regarding the lifeline portion of the LE retractable must be at least 90 degrees.
- 2 The anchor point for the LE retractable must be at the same height or higher than the leading edge over which a fall may occur. An anchor point situated below the level of a leading edge could cause the lifeline portion of the retractable to exceed a 90 degree angle over the edge in the event of a fall.
- 3 The user must not work on the far side of an opening opposite his/her anchor point for the LE retractable.
- 4 The user must be aware of all situations which may limit the work area in relation to the anchor point. Factors such as swing fall and abrasion of the lifeline at the Leading Edge should be considered during development of the fall protection plan.

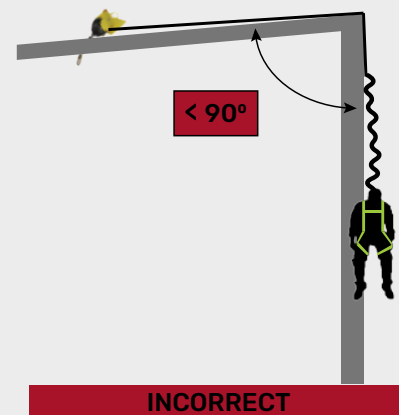
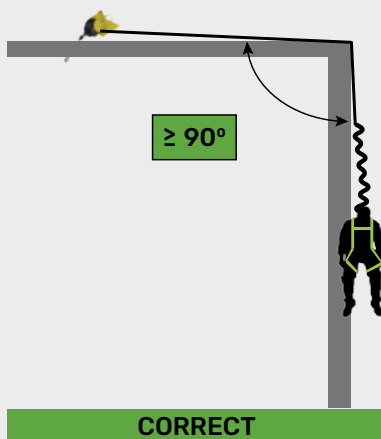

# FALL CLEARANCE - SRLS



**THIS IS ONLY AN EXAMPLE**

\* Note: Numbers used in these examples are based on ZERO offset and setback with the anchor directly overhead or below to represent an inline fall clearance calculation. Consult with your competent person when working in different scenarios and when using non-Safewaze equipment.

**WARNING!**

\*ELIMINATE SWING FALL BY WORKING AS CLOSE TO AND INLINE TO THE ANCHORAGE AS POSSIBLE

NOTE: DO NOT EXCEED 4' SWING FALL DROP DISTANCE PER ANSI Z359.6-2016

# LATITUDE EDGE

The Latitude Edge 8' Web Personal SRLs are state-of-the-art devices packed with all the critical features - and so much more. These unique SRLs boast an exclusive dorsal bracket and proprietary webbing for an experience unlike any other.

- Lightweight, durable housing design
- Exclusive dorsal attachment bracket with SRL separator feature
- Compact shock pack design with harness restraint strap
- 360/180° attachment point offers full range of motion
- Side payout for smooth retraction
- Exclusive edge resistant engineered composite webbing
- Protective label cover for product longevity and traceability
- Class 2 SRL-P for use above or below dorsal D-ring
- Weight Capacity ANSI 130-310 lbs., OSHA 420 lbs.
- ANSI Z359.14-2021, OSHA 1910.140, 1910.66
- All components are Z359.12 compliant

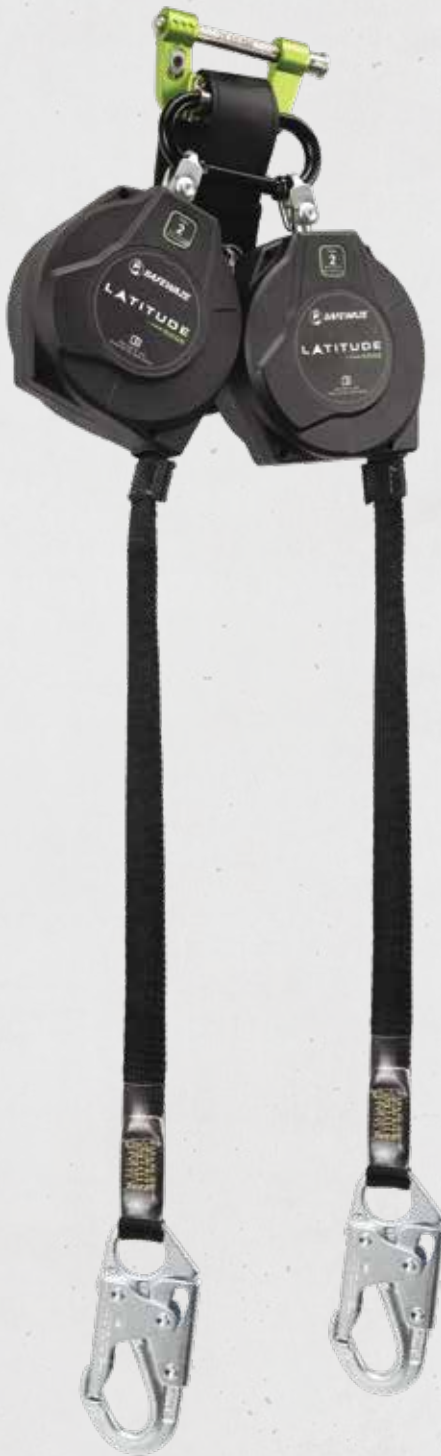

Proprietary Webbing



Swivel Attachment



Harness Restraint Strap



Lightweight, Durable Housing



Bracket with SRL Separator



Side Payout



**8' Dual Leg Web SRL-P Options**



Integrated Behind  
The Web Bracket

	Aluminum Carabiners	023-5349
	Steel Snap Hooks	023-5345
	Aluminum Snap Hooks	023-5347
	Steel Rebar Hooks	023-5346
	Aluminum Rebar Hooks	023-5348

**8' Single Leg Web SRL-P Options**



Integrated Behind  
The Web Bracket

	Aluminum Carabiner	023-5344
	Steel Snap Hook	023-5340
	Aluminum Snap Hook	023-5342
	Steel Rebar Hook	023-5341
	Aluminum Rebar Hook	023-5343

# LATITUDE EDGE

The Latitude Edge 8' Cable Personal SRLs are state-of-the-art devices packed with all the critical features - and so much more. These unique SRLs boast an exclusive dorsal bracket and frameless design for an experience unlike any other.

- Durable stainless steel housing with nylon sides
- Frameless design creates thinner housing size
- Exclusive dorsal attachment bracket with SRL separator feature
- Compact shock pack design with harness restraint strap
- 360/180° attachment point offers full range of motion
- Side payout for smooth retraction
- Protective label cover for product longevity and traceability
- RFID equipped
- Class 2 SRL-P for use above or below dorsal D-ring
- Weight Capacity ANSI 130-310 lbs., OSHA 420 lbs.
- ANSI Z359.14-2021, OSHA 1910.140, 1910.66
- All components are Z359.12 compliant



Galvanized Steel Cable



Swivel Attachment



Harness Restraint Strap



Steel and Glass Nylon Housing



Bracket with SRL Separator





RFID Enabled

**8' Dual Leg Cable SRL-P Options**





Integrated Behind  
The Web Bracket

	Aluminum Carabiners	023-5359
	Steel Snap Hooks	023-5355
	Aluminum Snap Hooks	023-5357
	Steel Rebar Hooks	023-5356
	Aluminum Rebar Hooks	023-5358

**8' Single Leg Cable SRL-P Options**



Integrated Behind  
The Web Bracket

	Aluminum Carabiner	023-5354
	Steel Snap Hook	023-5350
	Aluminum Snap Hook	023-5352
	Steel Rebar Hook	023-5351
	Aluminum Rebar Hook	023-5353

# LATITUDE EDGE

The Latitude Edge 11' Cable Personal SRLs incorporate a distinctive energy absorbing system within a lightweight backpack-style pouch. Engineered specifically for foot-level and sharp edge applications commonly found on construction sites.

- Mesh lined shock pack cover for cool-air comfort
- Harness fastener straps for added security
- Easy attachment with behind-the-web bracket
- Durable housing for added dependability
- 360/180° attachment point offers full range of motion
- Class 2 SRL-P for use above or below dorsal D-ring
- Weight Capacity ANSI 130-310 lbs., OSHA 420 lbs.
- ANSI Z359.14-2021, OSHA 1910.140, 1910.66
- All components are Z359.12 compliant



Galvanized Steel Cable



Behind The Web Bracket



Nylon Housing



Mesh Lined Cover



Dual SRL Bracket



Swivel Attachment

**11' Dual Leg Cable Options**



Integrated Behind  
The Web Bracket

	<b>Steel Snap Hooks</b>	<b>SW8008-11LE-DL</b>
	<b>Aluminum Snap Hooks</b>	<b>SW8008-11LE-ALUDL</b>
	<b>Steel Rebar Hooks</b>	<b>SW8008-11LE-RBHDL</b>
	<b>Aluminum Rebar Hooks</b>	<b>SW8008-11LE-RBHALUDL</b>

**11' Single Leg Cable Options**



Integrated Behind  
The Web Bracket

	<b>Steel Snap Hook</b>	<b>SW8008-11LE</b>
	<b>Aluminum Snap Hook</b>	<b>SW8008-11LE-ALU</b>
	<b>Steel Rebar Hook</b>	<b>SW8008-11LE-RBH</b>
	<b>Aluminum Rebar Hook</b>	<b>SW8008-11LE-RBHALU</b>

# LATITUDE PRO

The Latitude Pro 7' Web Personal SRLs are built with a revolutionary braking system that increases dependability. A semi-sealed assembly extends product life and unique translucent housing aids in the inspection of internal components.

- Internal braking system eliminates external shock pack
- Semi-sealed assembly protects internal components
- Translucent housing allows inspection of webbing, reserve line and pawl assembly
- 360/180° attachment point offers full range of motion
- Protective label cover for product longevity and traceability
- Class 1 SRL-P for use at or above dorsal D-ring
- Weight Capacity ANSI 130-310 lbs., OSHA 420 lbs.
- ANSI Z359.14-2021, OSHA 1910.140, 1910.66
- All components are Z359.12 compliant



20mm Dyneema®  
Webbing



Protective Label Cover



Semi-Sealed Pawl  
Assembly



High Strength  
Resin Housing



Bracket Options



Swivel Attachment









**7' Dual Leg Web Options**



				
		FS-EX313 Bracket, Carabiner	9013 Behind The Web Bracket	9012 Behind The Web Bracket
	Steel Snap Hooks	018-5016	018-5024	023-5366
	Aluminum Snap Hooks	018-5017	018-5025	021-5288
	Steel Rebar Hooks	018-5018	018-5026	023-5330
	Aluminum Rebar Hooks	018-5019	018-5027	023-5367

**7' Single Leg Web Options**



					
		No Connector	Steel Carabiner	Triple Lock Steel Carabiner	Aluminum Carabiner
	Steel Snap Hook	018-5000	018-5004	018-5008	018-5012
	Aluminum Snap Hook	018-5001	018-5005	018-5009	018-5013
	Steel Rebar Hook	018-5002	018-5006	018-5010	018-5014
	Aluminum Rebar Hook	018-5003	018-5007	018-5011	018-5015

# LATITUDE PRO TIE BACK

The Latitude Pro Tie-Back 7' Web Personal SRLs offer self-anchoring convenience with all the features of our Latitude Pro. The 20" length is ideal where longer webbing may create a hazard while the 40" allows greater anchoring flexibility.

- Tie-back convenience when no anchor is available
- Dependable 5000 lb. rated gate, steel tie-back snap hook
- Internal braking system eliminates external shock pack
- Semi-sealed assembly protects internal components
- Translucent housing allows easy inspection of webbing, reserve line and pawl assembly
- 360/180° attachment point offers full range of motion
- 20 mm Dyneema® webbing
- Full wear pad protection and label cover for product longevity
- Class 1 SRL-P for use at or above dorsal D-ring
- Weight Capacity ANSI 130-310 lbs., OSHA 420 lbs.
- OSHA 1910.140, 1910.66
- All components are Z359.12 compliant



## 7' Single Leg 40" Tie-Back Options



No Connector



Steel Carabiner



Triple Lock Steel Carabiner



Aluminum Carabiner

### ANCHORAGE CONNECTIONS FROM 9.5" TO 36"

Steel Snap Hook	018-5028	018-5029	018-5030	018-5031
-----------------	----------	----------	----------	----------





7' Dual Leg 20" Tie-Back Options



9013 Behind The Web Bracket



9012 Behind The Web Bracket

ANCHORAGE CONNECTIONS FROM 9.5" TO 18"

Steel Snap Hooks	018-5037	023-5368
------------------	----------	----------

7' Dual Leg 40" Tie-Back Options



FS-EX313 Bracket



FS-EX313 Bracket, Carabiner



FS-EX313 Bracket, Triple Lock Steel Carabiner



9013 Behind The Web Bracket



9012 Behind The Web Bracket

ANCHORAGE CONNECTIONS FROM 9.5" TO 36"

Steel Snap Hooks	018-5032	018-5033	018-5034	018-5036	023-5371
------------------	----------	----------	----------	----------	----------

# LATITUDE PRO ARC FLASH



Arc Flash

The Latitude Pro Arc Flash 7' Web Personal SRLs include all the features of our Latitude Pro plus Kevlar® webbing for premium performance in multiple extreme heat environments: arc flash, hot works and welding.

- Kevlar® webbing and Nomex® flame-resistant label cover
- Side payout for smooth retraction
- Internal braking system eliminates external shock pack
- 360/180° attachment point offers full range of motion
- Translucent housing allows easy inspection of webbing, reserve line and pawl assembly
- Semi-sealed assembly protects internal components
- Class 1 SRL-P for use at or above dorsal D-ring
- Weight Capacity ANSI 130-310 lbs., OSHA 420 lbs.
- ANSI Z359.14-2021, OSHA 19110.140, 1910.66, ASTM F887
- All components are Z359.12 compliant



360/180° Attachment Point



Side Payout Housing

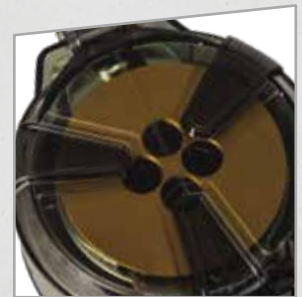

Clear Resin Housing

## 7' Dual Leg Web Options



9013 Behind The Web Bracket



9012 Behind The Web Bracket

	9013 Behind The Web Bracket	9012 Behind The Web Bracket
Steel Snap Hooks	020-5213	020-5217
Aluminum Snap Hooks	020-5215	020-5219
Steel Rebar Hooks	020-5214	020-5218
Aluminum Rebar Hooks	020-5216	020-5220
Dielectric Snap Hooks	020-5221	—

7' Single Leg Web Options



	Steel Carabiner	9013 Behind The Web Bracket
Steel Snap Hook	020-5200	020-5204
Aluminum Snap Hook	020-5202	020-5206
Steel Rebar Hook	020-5201	020-5205
Aluminum Rebar Hook	020-5203	020-5207
Dielectric Snap Hook	—	020-5208



**Latitude Pro Arc Flash 7' Single Web SRL-P:**  
Aramid Soft Loop, DE Snap Hook  
**022-5308**

- Non-conductive connections at both ends
- Soft loop chokes around harness dorsal D-ring or anchor point
- Dielectric snap hook connection



**Latitude Pro Arc Flash 7' Single Web SRL-P:**  
13" Aramid Ext. w/ Alu Snap Hook, Alu Captive Eye Carabiner  
**022-5309**

- 13" Aramid extender blocks current between attachment point and SRL housing
- Captive eye carabiner connection



**Latitude Pro Arc Flash 7' Single Web SRL-P:**  
18-22" Adj. Aramid Ext., Alu Captive Eye Carabiners  
**022-5310**

- 8-22" Aramid extender blocks current between attachment point and SRL housing
- Adjustable to keep housing away from bucket controls
- Captive eye carabiner connection



# LATITUDE

The Latitude 6' Web Personal SRLs are compact and lightweight for ease-of-use and all-day comfort. Features enhanced mobility plus the convenience of direct harness connection. Designed to arrest falls within inches, this SRL is an ideal solution for low heights.

- Quick-locking unit designed for use at low heights
- 360/180° attachment point offers full range of motion
- Durable housing increases strength and longevity
- High-strength, lightweight 20 mm UHMPE webbing
- Class 1 SRL-P for use at or above dorsal D-ring
- Weight Capacity ANSI 130-310 lbs., OSHA 420 lbs.
- ANSI Z359.14-2021, OSHA 1910.140, 1910.66
- All components are Z359.12 compliant

## 6' Dual Leg Web Options









9013 Behind The Web Bracket

9012 Behind The Web Bracket

	9013 Behind The Web Bracket	9012 Behind The Web Bracket
Steel Snap Hooks	019-5052	019-5056
Aluminum Snap Hooks	019-5053	019-5057
Steel Rebar Hooks	019-5054	019-5058
Aluminum Rebar Hooks	019-5055	019-5059



**6' Single Leg Web Options**



				
	No Connector	Steel Carabiner	Aluminum Carabiner	
	Steel Snap Hook	019-5040	019-5044	019-5048
	Aluminum Snap Hook	019-5041	019-5045	019-5049
	Steel Rebar Hook	019-5042	019-5046	019-5050
	Aluminum Rebar Hook	019-5043	019-5047	019-5051

**Tie-Back Options with Replaceable Leg**



			
	<b>DUAL LEG</b> 9013 Behind The Web Bracket	<b>SINGLE LEG</b> 9013 Behind The Web Bracket	
	Aluminum Snap Hook	021-5278	021-5282



	Choker Style Connection Point	
	Aluminum Snap Hook	021-5279



# LATITUDE HD

The Latitude HD Personal SRLs feature superior durability with heavy duty housing and high-strength webbing or cable. An innovative internal braking system eases shock and minimizes arrest distance, perfect for use in low clearance.

- Internal braking system eliminates external shock pack
- Durable housing increases strength and longevity
- 360/180° attachment point offers full range of motion
- 25 mm UHMPE webbing or 4.8 mm galvanized steel cable
- Class 1 SRL-P for use at or above dorsal D-ring
- Weight Capacity ANSI 130-310 lbs., OSHA 420 lbs.
- ANSI Z359.14-2021, OSHA 1910.140, 1910.66
- All components are Z359.12 compliant

## 7' Dual Leg Web Options



FS-EX313 Bracket, Carabiner



9012 Behind The Web Bracket

Steel Snap Hooks	FS-FSP14075-W	023-5369
Steel Rebar Hooks	FS-FSP14085-W-RBH	023-5370

**7' Single Leg Web Options**



**Steel Carabiner**



<b>Steel Snap Hook</b>	<b>FS-FSP1407-W</b>
<b>Steel Rebar Hook</b>	<b>FS-FSP1407-W-RBH</b>

**7' Dual Leg Web, 20" Tie-Back**



**FS-EX313 Bracket, Carabiner**



<b>Tie-Back Snap Hooks</b>	<b>FS-FSP14075-W-TBH</b>
----------------------------	--------------------------

**7' Single Leg Web, 20" Tie-Back**



**Steel Carabiner**



<b>Tie-Back Snap Hook</b>	<b>FS-FSP1407-W-TBH</b>
---------------------------	-------------------------

9' Dual Leg Web Options



FS-EX313  
Bracket, Carabiner



Steel Snap Hooks	FS-FSP1409-W-DL
Steel Rebar Hooks	FS-FSP1409-W-DL-RBH

9' Single Leg Web Options



Steel  
Carabiner



Steel Snap Hook	FS-FSP1409-W
Steel Rebar Hook	FS-FSP1409-W-RBH



**10' Dual Leg Cable Options**



**9012 Behind  
The Web Bracket**



**Steel  
Snap Hooks**

**SW8008-10-DL**



**Aluminum  
Snap Hooks**

**SW8008-10-ALU-DL**



**Steel  
Rebar Hooks**

**SW8008-10-RBH-DL**



**Aluminum  
Rebar Hooks**

**SW8008-10-ALU-RBHDL**

**10' Single Leg Cable Options**



**Steel  
Carabiner**



**Steel  
Snap Hook**

**SW8008-10**



**Aluminum  
Snap Hook**

**SW8008-10-ALU**



**Steel  
Rebar Hook**

**SW8008-10-RBH**



**Aluminum  
Rebar Hook**

**SW8008-10-ALU-RBH**

11' Dual Leg Web Options



Steel Snap Hooks	FS-FSP14095-W
Steel Rebar Hooks	FS-FSP14095-W-RBH



FS-EX313 Bracket, Carabiner

11' Single Leg Web Options



Steel Snap Hook	FS-FSP1411-W
Steel Rebar Hook	FS-FSP1411-W-RBH



Steel Carabiner

**11' Single Leg Cable Options**



**Steel Carabiner**

**LI Swivel Snap Hook**

**FS-FSP1211-G**

**LI Swivel Rebar Hook**

**FS-FSP1211-G-RBH**

**11' Tie Back Option**



**Steel Carabiner**

**Tie-Back Snap Hook**

**FS-FSP1411-W-TBH**



**INTERESTED IN THE  
NEWEST RELEASES  
FOR SRLS?**

Scan this code to view them now!





# VERTICAL LIFELINES

The hands-free, continuous movement of our vertical lifeline systems keeps you working. Whether climbing a ladder or performing maintenance on any vertical surface, our systems offer easy installation and use while maintaining a secure overhead connection.



## PRO

The PRO Vertical Lifeline assortment utilizes high-strength 5/8" 100% polyester rope.

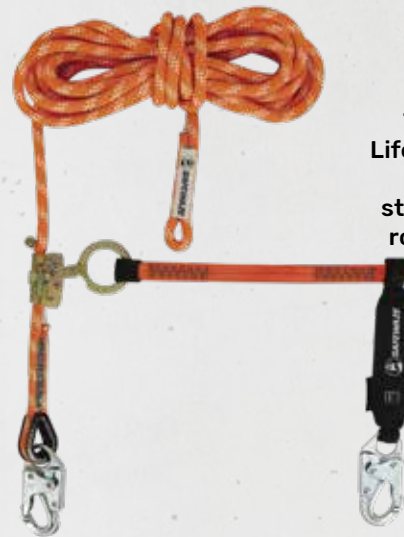

## V-LINE

The V-Line Vertical Lifeline assortment is built with super strength kernmantle rope or our abrasion resistant 5/8" copolymer rope.



## FALL ARRESTERS

Critical additions or replacement parts for your vertical access VLL system. Offering top of the line fall arresters and rope grabs including both manual and trailing versions, plus complete rope grab assemblies.



## COMPONENTS

Products designed specifically for your vertical access needs including termination plate anchor point, edge protectors and bulk rope.



**PRO**  
**PRO 50' VERTICAL LIFELINE ASSEMBLY: SNAP HOOK, ROPE GRAB, EA LANYARD**

FS700-50GA-3E

The PRO 50' Vertical Lifeline Assembly is a complete solution for roofing, swing stages, scaffolding or wherever fall protection is needed for vertical descend and ascend tasks. Built with rope that is stronger than synthetic versions as well as UV, cut and abrasion-resistant.

- Premium 5/8" 100% polyester rope
- Non-removable quick locking manual rope grab with dual-cam
- 3' web energy absorbing lanyard
- Minimum Breaking Strength: 5,000 lbs.
- Rope Tensile Strength: 7,500 lbs.
- Weight Capacity ANSI 130-310 lbs.
- ANSI Z359.13-2013, OSHA 1926.502, 1910.66, 1910.140



Polyester Rope



Energy Absorbing Lanyard

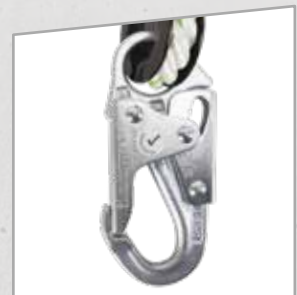

Steel Snap Hook



Captive Eye



Label Cover



Steel Rope Grab



### PRO 50' Vertical Lifeline Assembly:

Snap Hook, Rope Grab

#### FS700-50GA

- Premium 5/8" 100% polyester rope
- Manual steel rope grab
- Steel snap hook
- Rope Tensile Strength: 7,500 lbs.
- Minimum Breaking Strength: 5,000 lbs.
- Weight Capacity ANSI 130-310 lbs.
- OSHA 1926.502, 1910.66, 1910.140

#### PRO Vertical Lifeline Assembly Options

PART NUMBER	DESCRIPTION
FS700-25GA	PRO 25' Vertical Lifeline Assembly: Snap Hook, Rope Grab
FS700-50GA	PRO 50' Vertical Lifeline Assembly: Snap Hook, Rope Grab



### PRO 50' Vertical Lifeline

#### FS700-50

- Premium 5/8" 100% polyester rope
- Steel snap hook
- Secure termination
- Rope Tensile Strength: 7,500 lbs.
- Minimum Breaking Strength: 5,000 lbs.
- Weight Capacity ANSI 130-310 lbs.
- ANSI Z359.15-2014, OSHA 1926.502, 1910.66, 1910.140

#### PRO Vertical Lifeline Options

PART NUMBER	DESCRIPTION
FS700-25	PRO 25' Vertical Lifeline
FS700-50	PRO 50' Vertical Lifeline
FS700-75	PRO 75' Vertical Lifeline
FS700-100	PRO 100' Vertical Lifeline
FS700-150	PRO 150' Vertical Lifeline
FS700-200	PRO 200' Vertical Lifeline
FS700-250	PRO 250' Vertical Lifeline
FS700-300	PRO 300' Vertical Lifeline



### PRO 30' Kernmantle Vertical Lifeline

#### 021-7019

- 7/16" polyester kernmantle rope
- Steel swivel snap hook
- Impact-resistant captive eye termination
- Rope Tensile Strength: 8,200 lbs.
- Minimum Breaking Strength: 5,000 lbs.
- Weight Capacity ANSI 130-310 lbs., OSHA 420 lbs.
- ANSI Z359.15-2014, OSHA 1926.502, 1910.66, 1910.140

#### PRO Kernmantle Vertical Lifeline Options

PART NUMBER	DESCRIPTION
021-7019	PRO 30' Kernmantle Vertical Lifeline
021-7020	PRO 50' Kernmantle Vertical Lifeline
021-7021	PRO 100' Kernmantle Vertical Lifeline

**V-LINE**

**V-LINE 50' VERTICAL LIFELINE ASSEMBLY: SNAP HOOK, ROPE GRAB, EA LANYARD**

018-7005

The V-Line 50' Vertical Lifeline Assembly is our complete economical solution for vertical work. Built with copolymer rope to provide mildew, rot and solvent-resistance, protection against abrasion and a melting point over 300 degrees.



- 5/8" copolymer rope
- Steel snap hooks
- Non-removable quick locking manual rope grab with dual-cam
- 3' web energy absorbing lanyard
- Minimum Breaking Strength: 5,000 lbs.
- Weight Capacity ANSI 130-310 lbs.
- ANSI Z359.13-2013, OSHA 1926.502, 1910.66, 1910.140



Copolymer Rope



Energy Absorbing Lanyard



Steel Snap Hook



Captive Eye



Label Cover



Rope Grab





**V-Line 60' Kernmantle Vertical Lifeline Assembly:**

Snap Hook, Rope Grab, EA Lanyard

**019-7008**

- 5/8" kernmantle rope
- Steel snap hooks
- Removable trailing rope grab with anti-panic feature
- 3' web energy absorbing lanyard
- Rope Tensile Strength: 7,500 lbs.
- Minimum Breaking Strength: 5,000 lbs.
- Weight Capacity ANSI 130-310 lbs.
- ANSI Z359.13-2013, Z359.15-2014, OSHA 1926.502, 1910.66, 1910.140

**V-Line Kernmantle Vertical Lifeline Assembly Options**

PART NUMBER	DESCRIPTION
019-7007	V-Line 30' Kernmantle Vertical Lifeline Assembly: Snap Hook, Rope Grab, EA Lanyard
019-7008	V-Line 60' Kernmantle Vertical Lifeline Assembly: Snap Hook, Rope Grab, EA Lanyard



**INTERESTED IN THE  
NEWEST RELEASES  
FOR VLLS?**

Scan this code to view them now!



## DRIFT 7/16" (11MM) ROPE FALL ARRESTER

022-7025

The Drift 7/16" (11mm) Rope Fall Arrester is an innovation in rope access, exclusive to Safewaze. Carabiner does not need to be removed from rope grab, making an easy connection to lifeline. With extra smooth travel action, automatic trailing and dual use modes, the Drift is loaded with premium features.



- Connect and disconnect with one hand
- Lightweight yet durable aluminum design
- Wear resistant Zytel® nylon rollers
- Stainless steel internal components
- Visual indicators for upright installation
- Ergonomically placed mode control switch
- Flared housing for pinch free use and reduced friction
- Double locking gate for added security
- Includes backup anchor descent cord
- Minimum Breaking Strength: 3,600 lbs.
- Weight Capacity ANSI 130-310 lbs.
- ANSI Z359.15-2014, OSHA 1926.502, 1910.66, 1910.140



### Trailing Rope Grab Assembly FS00SP/FS1118-3

- Removable, smooth trailing grab
- Anti-panic feature for added safety
- Fits 5/8" (16 mm) rope
- 3' web energy absorbing lanyard
- Minimum Breaking Strength: 5,000 lbs.
- Weight Capacity ANSI 130-310 lbs.
- ANSI Z359.13-2013, Z359.15-2014, OSHA 1926.502, 1910.66, 1910.140



### Self-Tracking Rope Grab Assembly FS00SP/FS1118-DC-3

- Zinc plated steel self-tracking grab
- Removable versatility
- Fits 5/8" (16 mm) rope
- 3' web energy absorbing lanyard
- Minimum Breaking Strength: 5,000 lbs.
- Weight Capacity ANSI 130-310 lbs.
- ANSI Z359.13-2013, Z359.15-2014, OSHA 1926.502, 1910.66, 1910.140



**Manual Rope Grab Assembly  
FS00SP/FS1117-3**

- Non-removable quick locking manual rope grab with dual-cam
- Fits 5/8" (16 mm) rope
- 3' web energy absorbing lanyard
- Minimum Breaking Strength: 5,000 lbs.
- Weight Capacity ANSI 130-310 lbs.
- ANSI Z359.13-2013, OSHA 1926.502, 1910.66, 1910.140



**Trailing Stainless Steel Rope Grab  
FS1118**

- Durable stainless steel
- Removable, smooth trailing grab
- Anti-panic feature for added safety
- Fits 5/8" (16 mm) rope
- Minimum Breaking Strength: 3,600 lbs.
- Weight Capacity ANSI 130-310 lbs.
- ANSI Z359.15-2014, OSHA 1926.502, 1910.66, 1910.140

**Trailing Rope Grab Options**

PART NUMBER	DESCRIPTION
FS1118	Trailing Stainless Steel Rope Grab
FS1120	Trailing Rope Grab (Zinc plated alloy steel)



**Self-Tracking Rope Grab  
FS1118-DC**

- Zinc plated steel
- Removable versatility
- Fits 5/8" (16 mm) rope
- Minimum Breaking Strength: 3,600 lbs.
- Weight Capacity ANSI 130-310 lbs.
- ANSI Z359.15-2014, OSHA 1926.502, 1910.66, 1910.140



**Manual Rope Grab  
FS1117**

- Zinc plated steel
- Non-removable and stationary
- Quick locking grab with dual-cam
- Fits 5/8" (16 mm) rope
- Minimum Breaking Strength: 3,600 lbs.
- Weight Capacity ANSI 130-310 lbs.
- OSHA 1926.502, 1910.66, 1910.140



## ROPE TERMINATION PLATE

FS875

The Rope Termination Plate is a vertical lifeline anchor designed to replace splicing in synthetic rope. Just attach a carabiner to the top hole and anchor. If traditional anchor point is unavailable, tieback feature can be used to choke off around a non-abrasive support member.

- Versatile and easy to use
- Ideal for fall protection, work positioning, rope access or rescue
- Use with 5/8" to 3/4" rope
- OSHA 1926.502, 1910.66, 1910.140



Carabiner and rope sold separately



**36" Rope Protector**  
**018-9001**



**18" Rope Protector**  
**018-9000**

- Built with highly durable tarpaulin material
- Strong web loop secures protector in place
- Easily installed and positioned for long lasting protection
- Hook and loop fastener



**Bulk Lifeline Rope: 1200'**  
**FS700-581200**

- Versatile bulk rope
- 100% premium polyester for added strength
- Rope Tensile Strength: 7,500 lbs.

**Bulk Lifeline Rope Sizes**

PART NUMBER	DESCRIPTION	LENGTH
FS700-581200	Bulk Lifeline Rope: 1200'	1200 ft.
FS700-58600	Bulk Lifeline Rope: 600'	600 ft.



**5lb. Rope Counterweight**  
**021-7014**

- Counterweight adds tension to VLL
- Improves performance of rope grab
- Provides consistent availability for counterweight
- Polyester cover with sand fill





# HORIZONTAL LIFELINES

Get the full range of motion you need across a variety of working surfaces with our range of horizontal lifeline systems. Ideal for leading edge and low clearance conditions as well as short or long span roofing environments. Easy installation and hands-free use for multiple users.



## SAFELINK SYSTEM

SafeLink cable horizontal lifeline systems offer reliable solutions for working on leading edge surfaces as well as other applications where horizontal work and low clearance fall hazards exist.



## CABLE SYSTEM

These 2 person cable horizontal lifeline systems are built for versatility. Offered with 2 different in-line energy absorber types for various work conditions.



## DOUBLE BRAID ROPE SYSTEM

These 4-person rope horizontal lifeline systems use lightweight energy absorbing double braided rope, an aluminum tensioner and swivel connection point. The ideal solution for multiple workers covering multiple applications.



## KERNMANTLE ROPE SYSTEM

These 2-person rope horizontal lifeline systems are built with a steel tensioner and abrasion resistant kernmantle rope. Combined with easy storage and transport, it's the perfect solution for shorter roofing environments or larger span jobs.



## SAFELINK BASES

Selection of bases, stanchions and baseplates and more designed to anchor horizontal lifeline systems on a wide variety of mounting surfaces.



## COMPONENTS

Essential accessories, replacement parts and individual components for all horizontal lifeline systems.

**SAFELINK**

**65' SAFELINK  
COME-A-LONG KIT**

FS-EX10000

The 65' SafeLink Come-A-Long Kit addresses the difficulties of working on subdued or leading edge surfaces as well as other applications where horizontal work and low clearance fall hazards exist. Fast-acting brake assembly stops user quickly in the event of a fall.

- 1-ton cable puller come-a-long
- StopLink brake assembly with built-in tension indicator
- Durable, corrosion-resistant cable
- Adjustable safety strap
- Fist-grip clamps and carabiners
- Convenient, extra large carry bag
- Weight Capacity ANSI 130-310 lbs., OSHA 420 lbs.
- OSHA 1926.502, 1910.140, 1910.66

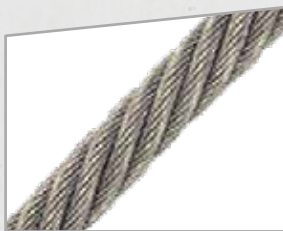

7x19 Galvanized Steel Cable



Safety Strap



StopLink Brake Assembly



Cable Puller Come-A-Long



Steel Carabiner



5/26" Double-Saddle Fist-Grip Clamp



Steel Cable



Carry Bag





**65' SafeLink HLL System:**

Turnbuckle Kit

**FS-EX10500**

- Turnbuckle cable tensioner
- StopLink brake assembly with built-in tension indicator
- Durable, corrosion-resistant cable
- Fist-grip clamps and carabiners
- Convenient, extra large carry bag
- Weight Capacity ANSI 130-310 lbs., OSHA 420 lbs.
- OSHA 1926.502, 1910.140, 1910.66





## QUADRANT RETRACTABLE HLL

023-8091

The Quadrant Retractable HLL offers jobsite flexibility as a temporary 2-person HLL system. The versatile length up to 65' allows use in a wide range of environments with user-friendly setup plus no-hassle cable storage in protective housing.

- Set cable at any length up to 65'
- Quick, easy setup with smooth payout
- Light, compact design with collapsible crank
- O-rings included to reduce cable wear
- Efficient dual-action tension release
- Built in fall indicator for easy inspection
- Free wheel mode for practical jobsite use
- Designed for stability when tensioning
- Power drill retraction adapter included
- Minimum Breaking Strength: 5,000 lbs.
- Weight Capacity ANSI 130-310 lbs.
- OSHA 1926.502, 1910.140, 1910.66

### 30' Cable HLL: No Anchor

019-8016



- Turnbuckle cable tensioner
- Corrosion-resistant 5/16" cable
- Coil energy absorber reduces impact forces
- O-rings included to reduce cable wear
- Fist-grip clamps, carabiners and cable thimble
- Carry and storage bag
- Weight Capacity ANSI 130-310 lbs., OSHA 420 lbs.
- OSHA 1926.502, 1910.140, 1910.66

#### Cable HLL Options

Part Number	Description
019-8016	30' Cable HLL: No Anchor
019-8017	60' Cable HLL: No Anchor
019-8018	80' Cable HLL: No Anchor
019-8019	100' Cable HLL: No Anchor



### 30' Cable HLL System:

Cross Arm Straps

#### 019-8020

- Turnbuckle cable tensioner
- Corrosion-resistant 5/16" cable
- Coil energy absorber reduces impact forces
- Heavy duty 6' cross-arm strap anchors
- O-rings included to reduce cable wear
- Fist-grip clamps, carabiners and cable thimble
- Carry and storage bag
- Weight Capacity ANSI 130-310 lbs., OSHA 420 lbs.
- OSHA 1926.502, 1910.140, 1910.66

#### Cable HLL Options

PART NUMBER	DESCRIPTION
019-8020	30' Cable HLL: Cross Arm Straps
019-8021	60' Cable HLL: Cross Arm Straps
019-8022	80' Cable HLL: Cross Arm Straps
019-8023	100' Cable HLL: Cross Arm Straps



### 30' Cable HLL System:

Cross Arm Straps, Web Energy Absorber

#### 019-8024

- Turnbuckle cable tensioner
- Corrosion-resistant 5/16" cable
- Web energy absorber with cover reduces impact forces
- Heavy duty 6' cross-arm strap anchors
- O-rings included to reduce cable wear
- Fist-grip clamps, carabiners and cable thimble
- Carry and storage bag
- Weight Capacity ANSI 130-310 lbs., OSHA 420 lbs.
- OSHA 1926.502, 1910.140, 1910.66

#### Cable HLL, Web Energy Options

PART NUMBER	DESCRIPTION
019-8024	30' Cable HLL: Cross Arm Straps, Web Energy Absorber
019-8025	60' Cable HLL: Cross Arm Straps, Web Energy Absorber
019-8026	80' Cable HLL: Cross Arm Straps, Web Energy Absorber
019-8027	100' Cable HLL: Cross Arm Straps, Web Energy Absorber

### 30' 4-PERSON ROPE HLL: CROSS ARM STRAPS

019-8012

The 4-Person Rope HLL with cross arm straps is our advanced rope kit built for durability and efficiency with multiple users with a rope that acts as the energy absorber.

- Rugged 16mm double braid rope
- Rope tensioner with built-in wrench
- Swivel connection eliminates twisted rope
- Heavy duty 6' cross-arm strap anchors
- Weight Capacity ANSI 130-310 lbs., OSHA 420 lbs.
- OSHA 1926.502, 1910.140, 1910.66

#### 4-Person Rope HLL Options

PART NUMBER	DESCRIPTION
019-8012	30' 4-Person Rope HLL: Cross Arm Straps
019-8013	60' 4-Person Rope HLL: Cross Arm Straps
019-8014	80' 4-Person Rope HLL: Cross Arm Straps
019-8015	100' 4-Person Rope HLL: Cross Arm Straps



### 30' Kernmantle Rope HLL:

No Anchor

019-8000

- Abrasion-resistant kernmantle rope
- Secure rope tensioner
- Web energy absorber with cover reduces impact forces
- Carry and storage bag
- Weight Capacity ANSI 130-310 lbs., OSHA 420 lbs.
- OSHA 1926.502, 1910.140, 1910.66

#### Kernmantle Rope HLL Options

PART NUMBER	DESCRIPTION
019-8000	30' Kernmantle Rope HLL: No Anchor
019-8001	60' Kernmantle Rope HLL: No Anchor
019-8002	80' Kernmantle Rope HLL: No Anchor
019-8003	100' Kernmantle Rope HLL: No Anchor





### 30' Kernmantle Rope HLL:

#### Cross Arm Straps

##### 019-8004

- Abrasion-resistant kernmantle rope
- Secure rope tensioner
- Web energy absorber with cover reduces impact forces
- Heavy duty 6' cross-arm strap anchors
- Carry and storage bag
- Weight Capacity ANSI 130-310 lbs., OSHA 420 lbs.
- OSHA 1926.502, 1910.140, 1910.66

#### Kernmantle Rope HLL Options

PART NUMBER	DESCRIPTION
019-8004	30' Kernmantle Rope HLL: Cross Arm Straps
019-8005	60' Kernmantle Rope HLL: Cross Arm Straps
019-8006	80' Kernmantle Rope HLL: Cross Arm Straps
019-8007	100' Kernmantle Rope HLL: Cross Arm Straps



### 30' Kernmantle Rope HLL:

#### Chain Anchors

##### 019-8008

- Abrasion-resistant kernmantle rope
- Secure rope tensioner
- Web energy absorber with cover reduces impact forces
- Easy-installation chain roof anchors
- Carry and storage bag
- Weight Capacity ANSI 130-310 lbs., OSHA 420 lbs.
- OSHA 1926.502, 1910.140, 1910.66

#### Kernmantle Rope HLL Options

PART NUMBER	DESCRIPTION
019-8008	30' Kernmantle Rope HLL: Chain Anchors
019-8009	60' Kernmantle Rope HLL: Chain Anchors
019-8010	80' Kernmantle Rope HLL: Chain Anchors
019-8011	100' Kernmantle Rope HLL: Chain Anchors

## SAFELINK FORM LINK ANCHOR

FS-EX2502

The SafeLink Form Link Anchor is for use as a base with the SafeLink HLL System. Easily installed on various structures.

- 2-piece aluminum bracket kit
- [2] steel threaded rods
- [2] wing nut brackets
- Use with FS-EX5501-5 aluminum posts
- Versatile mounting:
  - [6] #7 or larger stirruped rebar
  - Finished wall (min. 8" thick)
  - Clamped around finished column
- Minimum Breaking Strength: 3,600 lbs.
- Weight Capacity ANSI 130-310 lbs.
- OSHA 1926.502, 1910.66

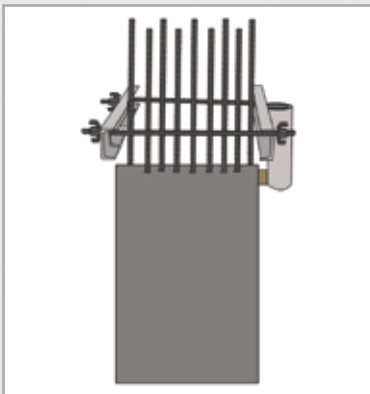
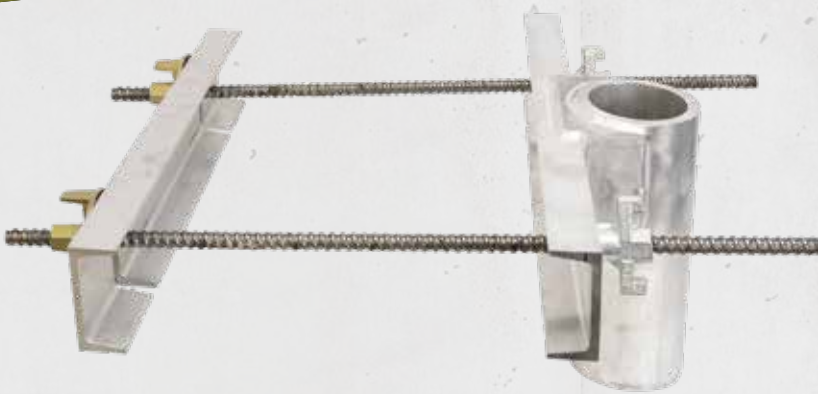

Single Installation

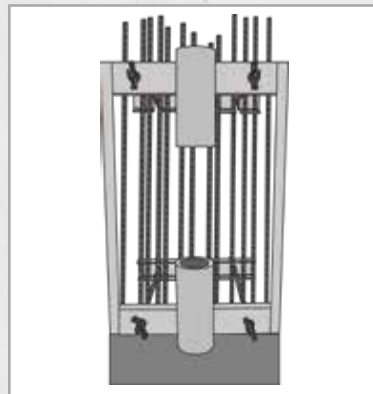

Double Installation



## SafeLink EZ-Link Double Connector

FS-EX2502-DBL

- 3-piece aluminum bracket kit
- [4] steel threaded rods
- [4] wing nut brackets
- Mounts easily to [6] #9 rebar or larger
- Use with FS-EX5501-5 aluminum posts
- 360° allowable work radius
- Minimum Breaking Strength: 5,000 lbs.
- OSHA 1926.502, 1910.66



### SafeLink PVC Sleeve FS-EX2504

- Cast in place at 11" min. depth
- 12" length, 4" inside diameter
- Use with FS-EX5501-5 aluminum posts
- OSHA 1926.502, 1910.66



### SafeLink Steel Sleeve 023-8089

- For use in seismic regions
- Cast in place at 11" min. depth
- 12" length, 3.7" inside diameter
- Use with FS-EX5501-5 aluminum posts
- OSHA 1926.502, 1910.66



### SafeLink Whizzler Swivel Cap FS-EX2514

- Full rotation with 360° swivel anchor point
- Use with FS-EX5501-5 aluminum posts
- Minimum Breaking Strength: 5,000 lbs.
- Weight Capacity ANSI 130-310 lbs.
- OSHA 1926.502, 1910.140, 1910.66



### Bolt-on SafeLink Post Baseplate 019-8034

- Mounts securely to steel or concrete
- Use with FS-EX5501-5 aluminum posts
- Minimum Breaking Strength: 5,000 lbs.
- Weight Capacity ANSI 130-310 lbs.
- OSHA 1926.502, 1910.66



**SafeLink 42" I-Beam Stanchion:**  
4" to 24"

**019-8046**

- Easily installs on most HLL systems
- Versatile use as single or multi-span
- Maximum 2 users per span
- Ideal for leading edge and low clearance
- Adjustable to mount to I-beams 4"-24"
- Fits I-beam flanges up to 2-1/4" thick
- Convenient built-in carrying handle
- Weight Capacity ANSI 130-310 lbs.
- OSHA 1926.502, 1910.66

**SafeLink I-Beam Stanchion Options**

PART NUMBER	DESCRIPTION
019-8046	SafeLink 42" I-Beam Stanchion: 4" to 24"
019-8038	SafeLink 42" I-Beam Stanchion: 4" to 18"
020-8060	SafeLink 42" I-Beam Stanchion: 4" to 12"

**SafeLink I-Beam Post Base:**  
6" to 14":

**022-8076**

- Easily installs on most HLL systems
- Versatile use as single or multi-span
- Maximum 2 users per span
- Adjustable to mount to I-beams 6"-14"
- Fits I-beam flanges up to 2-1/4" thick
- Convenient built-in carrying handle
- Weight Capacity ANSI 130-310 lbs.
- OSHA 1926.502, 1910.66

**SafeLink I-Beam Post Options**

PART NUMBER	DESCRIPTION
022-8076	SafeLink I-Beam Post Base: 6" to 14"
022-8077	SafeLink I-Beam Post Base: 6" to 36"

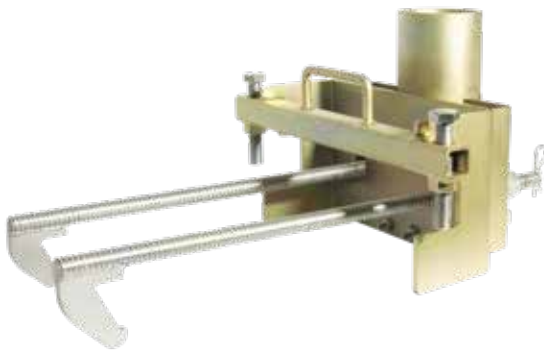





**SafeLink Nelson/Rebar Assembly**  
**023-8087**

- Fits nelson stud, L-shaped and straight rebar
- Adjustable clamps fit 1/2"-1-3/8" diameter with 2.5"-7.25" spacing
- Quick installation on most HLLs with minimal hardware
- Reduced trip hazard with 3-4' footprint
- Durable long-lasting construction
- Versatile use as single or multi-span
- Maximum 2 users per span
- Use with FS-EX5501-5 aluminum posts
- Minimum Breaking Strength: 5,000 lbs.
- Weight Capacity ANSI 130-310 lbs.
- OSHA 1926.502, 1910.66



**SafeLink Pass-Through Bracket**  
**019-8039**

- Durable long-lasting construction
- Use with 019-8046, 019-8038, 020-8060
- Weight Capacity ANSI 130-310 lbs.
- OSHA 1926.502, 1910.66



**SafeLink Loop Rebar Base**  
**019-8051**

- Lightweight construction
- Perfect for overpasses, bridges and roadwork
- Adjustable base to fit angled surfaces
- Qualified person required for installation
- Weight Capacity ANSI 130-310 lbs.
- System Capacity up to 1240 lbs.
- OSHA 1926.502, 1910.66

The **SafeLink Loop Rebar Base** is part of a complete solution for mounting Horizontal Lifeline Systems.

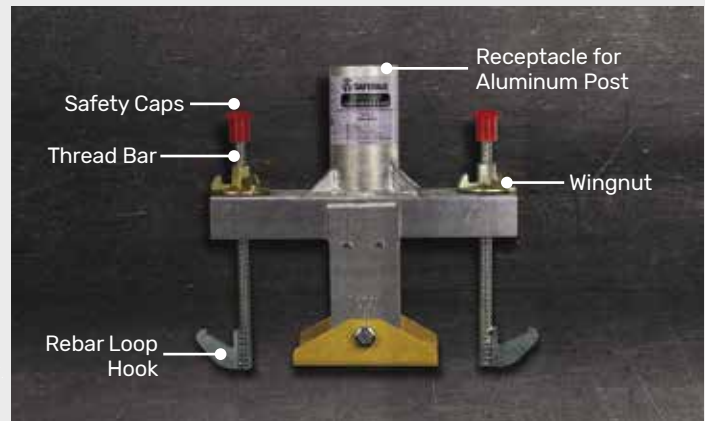

**Single Span Installation**

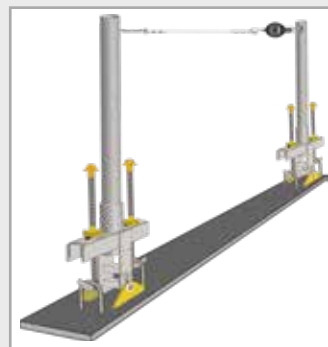

**Intermediate Span Installation**





## SAFEWAZE STOPLINK BRAKE V2

019-8044

The StopLink Brake V2 is an inline energy absorber for the SafeLink HLL System. This brake drastically reduces force on the anchor while providing low minimum clearance heights.

- Exclusive brake design reduces force
- Integral tension indicator for quick, accurate verification
- Easy view activation window
- High strength UHMW webbing
- Weight Capacity ANSI 130-310 lbs.
- System Capacity up to 1240 lbs.
- OSHA 1926.502, 1910.66



### Tension Indicator

019-8031

- Easy view activation window
- Color coded indicator
- High memory/rebound spring
- Minimum Breaking Strength: 5,000 lbs.
- Weight Capacity ANSI 130-310 lbs.
- OSHA 1926.502, 1910.66



### Coil Energy Absorber: Shackles

019-8028

- Compact and lightweight
- Easy set-up and use
- Versatile, fits most cable HLL systems
- Works on 5,000 lb. anchor point
- OSHA 1926.502, 1910.66

#### Coil Energy Absorber Options

PART NUMBER	DESCRIPTION
019-8028	Coil Energy Absorber: Shackles
019-8029	Coil Energy Absorber



### HLL Energy Absorber: Shackle

019-8030

- Efficient tear webbing reduces force
- Durable abrasion-resistant cover
- Stainless steel shackle
- Use with rope and cable HLL systems
- Works on 5,000 lb. anchor point
- OSHA 1926.502, 1910.66



**SafeLink Come-A-long**

**FS-EX2510**

- Durable construction
- 12' of high-strength aircraft cable
- Comfortable rubber grip handle
- Minimum Breaking Strength: 5,000 lbs.
- OSHA 1926.502, 1910.66



**10' Cross-Arm Strap**

**FS88811-HW-10**

- Durable tubular strap webbing
- Ideal for HLL use (additional lengths under anchors)
- Minimum Breaking Strength: 5,000 lbs.
- Weight Capacity ANSI 130-310 lbs., OSHA 420 lbs.
- ANSI Z359.18-2017 Type T, OSHA 1926.502, 1910.140, 1910.66



**SafeLink Strap**

**FS-EX2505**

- Adjustable length up to 4'
- Wear sleeves at both ends
- Installs as backup safety point
- Minimum Breaking Strength: 5,000 lbs.
- OSHA 1926.502, 1910.66



**SafeLink Turnbuckle**

**019-8036**

- Solid drop-forged construction
- Adjusts from 18" to 28"
- Shackle ends with locking bolts
- Minimum Breaking Strength: 5,000 lbs.
- OSHA 1926.502, 1910.66



**SafeLink I-Beam Base: 4" to 18"**

**019-8047**

- Equipped with adjustable clamp
- Includes fastener set and mounting bolts
- Replacement part for 019-8046
- OSHA 1926.502, 1910.66



**SafeLink Snatch Block**

**FS-EX320**

- Heavy duty with protective coating
- Swivel shackle for full rotation
- Secure locking bolt
- Minimum Breaking Strength: 5,000 lbs.
- OSHA 1926.502, 1910.66

**SafeLink I-Beam Base Options**

PART NUMBER	DESCRIPTION
019-8047	SafeLink I-Beam Base: 4" to 18"
019-8041	SafeLink I-Beam Base: 4" to 24"



**SafeLink I-Beam Upright**  
**019-8040**

- Convenient integrated carry handle
- Replacement part for 019-8046
- OSHA 1926.502, 1910.66



**SafeLink I-Beam Clamp:**  
4" to 24"  
**019-8042**

- Adjustable size options
- Replacement part for 019-8046
- OSHA 1926.502, 1910.66

**SafeLink I-Beam Clamp Options**

PART NUMBER	DESCRIPTION
019-8042	SafeLink I-Beam Clamp, 4" to 24"
019-8045	SafeLink I-Beam Clamp, 4" to 18"



**SafeLink Anchor Post**  
**FS-EX5501-5**

- Sturdy, lightweight aluminum
- Designed to secure overhead lifeline
- 7.5' height, 3.5" outer diameter
- Minimum Breaking Strength: 5,000 lbs.
- OSHA 1926.502, 1910.66

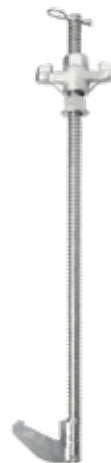

**SafeLink I-Beam Post Base Clamp:**  
6"-14"  
**022-8078**

- Adjustable to mount to I-beams 6"-14"
- Replacement part for 019-8076
- OSHA 1926.502, 1910.66

**SafeLink I-Beam Post Base Clamp Options**

PART NUMBER	DESCRIPTION
022-8078	SafeLink I-Beam Post Base Clamp: 6"-14"
022-8079	SafeLink I-Beam Post Base Clamp: 6"-36"



**SafeLink Steel Cable**  
**FS-EX2500-GA**

- Corrosion-resistant galvanized steel
- Captive eye on one end
- Versatile use on subdued or leading edge
- Minimum Breaking Strength: 9,000 lbs.
- OSHA 1926.502, 1910.66



**SafeLink Nelson/  
Rebar Support Base**  
**023-8094**

- Replacement part for 023-8087
- OSHA 1926.502, 1910.66
- Not for standalone use

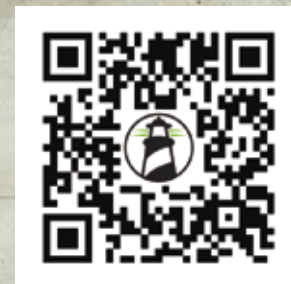

**INTERESTED IN  
THE NEWEST  
RELEASES FOR HLLS?**

Scan this code to view them now!





**HLL Termination Kit**  
**019-8033**

- Built for 5/16" cable on all HLLs
- Replacement kit to secure ends
- Weight Capacity ANSI 130-310 lbs.
- OSHA 1926.502, 1910.66



**HLL Installation Kit**  
**019-8032**

- Compact, lightweight coil energy absorber
- Turnbuckle tensioner for 5/16" cable
- Comprehensive starter kit
- Weight Capacity ANSI 130-310 lbs.
- OSHA 1926.502, 1910.66



**SafeLink Eye Bolt**  
**FS-EX2508**

- Secure captive eye bolt
- Use with FS-EX5501-5 aluminum posts
- Minimum Breaking Strength: 5,000 lbs.
- OSHA 1926.502, 1910.140, 1910.66



**SafeLink Heavy Duty Shackle**  
**019-8037**

- Durable bolt fastener with secure pin
- Used for connection on all HLLs
- Minimum Breaking Strength: 5,000 lbs.
- OSHA 1926.502, 1910.66



**SafeLink Nelson/Rebar Clamp Set**  
**023-8092**

- Fits nelson stud, L-shaped and straight rebar
- Replacement part for 023-8087, 023-8093, 023-8094
- OSHA 1926.502, 1910.66



**SafeLink Nelson/Rebar Collared Base**  
**023-8093**

- Standalone intermediate base
- Replacement part for 023-8087
- OSHA 1926.502, 1910.66



**SafeLink Fist Grip**  
**019-8050**

- Built for 5/16" cable
- Minimum Breaking Strength: 5,000 lbs.
- OSHA 1926.502, 1910.66



**SafeLink Wing Nut Bracket**  
**SW-EX177**

- Replacement for FS-EX2502
- OSHA 1926.502, 1910.66



**SafeLink Clamp Wing Nut**  
**019-8043**

- Replacement part for all sizes
- OSHA 1926.502, 1910.66



**SafeLink Wing Nut**  
**SW-EX178**

- Replacement for FS-EX2502
- OSHA 1926.502, 1910.66



# LADDER CLIMB SYSTEMS

Take the next step in ladder safety with our flexible cable systems engineered to deliver long-lasting durability. Easy to install with permanent one-time setup, including options to ensure safe rooftop transitions, save time with access for multiple users or custom build your system.



## 2-PERSON SYSTEM

2-Person flexible cable ladder climbing system with options in a wide range of heights.

**2-Person and 4-Person systems available in original galvanized steel and also in corrosion-resistant stainless steel.**



### **2-PERSON/ EXTENDED TOP SYSTEM**

2-Person flexible cable ladder climbing system with extended top to ensure safe rooftop transitions.



### **4-PERSON SYSTEM**

4-Person flexible cable ladder climbing system for faster access with multiple users.



### **LADDER ANCHORS**

Permanent or temporary anchorage for SRLs. System attaches to existing ladder rungs.



### **HATCH SYSTEMS**

Open, close and secure roof access hatches from ground level. Includes post for safe rooftop transitions.



### **COMPONENTS**

Additional system parts or replacement parts to build your own system. The component section covers it all.



## 20' LADDER CLIMB SYSTEM, COMPLETE KIT

019-12001

This Ladder Climb System is engineered for durability and convenience. The flexible cable kit is easily installed on standard rung attachments.

- 2-person top bracket
- 3/8" corrosion-resistant cable
- Pre-swaged termination
- 3,600 lb. single user anchor point
- Tension retaining base bracket
- Includes mounting hardware and inspection label
- Weight Capacity ANSI 130-310 lbs., OSHA 420 lbs.
- System Capacity up to 620 lbs.
- ANSI A14.3, OSHA 1910.29, 1926.1053, 1926.502, 1910.140



Intermediate Guide  
*SOLD SEPARATELY*



Anchor Point



Energy Absorbing Head Unit

*All 2-Person Ladder Climb Systems are available in original galvanized steel or long-lasting stainless steel.*

### 2-Person Ladder Climb System Options

PART NUMBER Galvanized Steel	PART NUMBER Stainless Steel	Length
019-12001	022-12111	20 ft.
019-12002	022-12112	30 ft.
019-12003	022-12113	40 ft.
019-12004	022-12114	50 ft.
019-12005	022-12115	60 ft.
019-12006	022-12116	70 ft.
019-12007	022-12117	80 ft.
019-12008	022-12118	90 ft.
019-12009	022-12119	100 ft.





**30' Extended Top Ladder Climb System, Complete Kit**  
**019-12032**

- 4' extended, 2-person top bracket with energy-absorbing head unit
- 3/8" corrosion-resistant cable
- Pre-swaged termination
- 3,600 lb. single user anchor point
- Tension retaining base bracket
- Includes mounting hardware and inspection label
- Weight Capacity ANSI 130-310 lbs., OSHA 420 lbs.
- System Capacity up to 620 lbs.
- ANSI A14.3, OSHA 1910.29, 1926.1053, 1926.502, 1910.140

**2-Person Extended Top System Options**

<b>PART NUMBER</b> Galvanized Steel	<b>LENGTH</b>
019-12032	30 ft.
019-12034	50 ft.
019-12036	70 ft.
019-12038	90 ft.

**30' Ladder Climb System, 4-Person Complete Kit**  
**019-12041**

- 4-person top bracket with energy-absorbing head unit
- 3/8" corrosion-resistant cable
- Pre-swaged termination
- 3,600 lb. single user anchor point
- Tension retaining base bracket
- Includes mounting hardware and inspection label
- Weight Capacity ANSI 130-310 lbs., OSHA 420 lbs.
- System Capacity up to 1240 lbs.
- ANSI A14.3, OSHA 1910.29, 1926.1053, 1926.502, 1910.140

*All 4-Person Ladder Climb Systems are available in original galvanized steel or long-lasting stainless steel.*

**4-Person Ladder Climb System Options**

<b>PART NUMBER</b> Galvanized Steel	<b>PART NUMBER</b> Stainless Steel	<b>LENGTH</b>
019-12041	022-12128	30 ft.
019-12043	022-12130	50 ft.
019-12045	022-12132	70 ft.
019-12047	022-12134	90 ft.





**4' Adjustable SRL Ladder Anchor System**  
**022-12146**

- Adjustable captive eye for sternal or dorsal connection
- Versatile use with all SRLs
- 4' post with top anchor extension bracket
- Durable powder coated stainless steel head
- Installs on fixed ladders only
- All mounting hardware included
- Minimum Breaking Strength: 3,600 lbs.
- Weight Capacity ANSI 130-310 lbs., OSHA 420 lbs.
- OSHA 1926.502, 1910.140

**Adjustable SRL Ladder Anchor System Options**

PART NUMBER	DESCRIPTION	LENGTH
022-12146	4' Adjustable SRL Ladder Anchor System	4 ft.
022-12147	6' Adjustable SRL Ladder Anchor System	6 ft.



## 10' TO 20' BELMONT SAFETY HATCH SYSTEM WITH FLAT BRACKETS

023-12154

The 10' to 20' Belmont Safety Hatch System is a complete solution for safe rooftop access when using a hatch from a fixed ladder. Operate hatch from the safety of the ground, leaving hands free for climbing. An innovative built-in pole extends at top to ensure smooth transitions between the ladder and roof.

- System mounts directly to ladder for stability
- Ground level operation to open, close and secure hatch
- Safe transitions with built-in extension pole
- Manually operated drive unit with simple crank
- For use on hatches from 30" square to 36" square
- Includes all required components and fasteners
- Drill bit rivet adapter also included
- System Capacity: 600 lbs.

*Systems available with flat, front mount or round brackets to fit most ladders.*

### Belmont Safety Hatch System Options

PART NUMBER	DESCRIPTION
023-12154	10' to 20' Belmont Safety Hatch System with Flat Brackets
023-12155	20' to 27' Belmont Safety Hatch System with Flat Brackets
023-12156	27' to 34' Belmont Safety Hatch System with Flat Brackets
023-12157	10' to 20' Belmont Safety Hatch System with Front Mount Brackets
023-12158	20' to 27' Belmont Safety Hatch System with Front Mount Brackets
023-12159	27' to 34' Belmont Safety Hatch System with Front Mount Brackets
023-12160	10' to 20' Belmont Safety Hatch System with Round Brackets
023-12161	20' to 27' Belmont Safety Hatch System with Round Brackets
023-12162	27' to 34' Belmont Safety Hatch System with Round Brackets
023-12163	Flat Backing Plate Set, Belmont Safety Hatch
023-12164	Front Mount Backing Plate Set, Belmont Safety Hatch
023-12165	Round Backing Plate Set, Belmont Safety Hatch





### EVO 3/8" DETACHABLE CABLE SLEEVE

020-12101

The EVO 3/8" Detachable Cable Sleeve is durable yet lightweight with an integral energy absorber. Unit automatically follows user and connects quickly and easily with one-handed action.

- Corrosion-resistant materials
- Secure internal cam locking system
- Innovative anti-inversion feature
- In-line web energy absorber to reduce arrest force
- Use with Safewaze ladder systems and any 3/8" cable
- Weight Capacity ANSI 130-310 lbs., OSHA 420 lbs.
- ANSI A14.3, OSHA 1926.502, 1910.140, 1910.66



### Top Bracket Assembly (2-Person)

019-12022

- Energy absorbing, powder coated, stainless steel head
- Corrosion-resistant post
- 3,600 lb. single user anchor point
- All mounting hardware included
- Weight Capacity ANSI 130-310 lbs., OSHA 420 lbs.
- System Capacity up to 620 lbs.
- ANSI A14.3, OSHA 1910.29, 1926.1053, 1926.502, 1910.140

#### Top Bracket Assembly (2-Person) Options

PART NUMBER Galvanized Steel	PART NUMBER Stainless Steel
019-12022	022-12102



### 4' Extended Top Bracket Assembly (2-Person)

**019-12023**

- Energy absorbing, powder coated, stainless steel head
- 86.5" corrosion-resistant galvanized steel post
- 3,600 lb. single user anchor point
- All mounting hardware included
- Weight Capacity ANSI 130-310 lbs., OSHA 420 lbs.
- System Capacity up to 620 lbs.
- ANSI A14.3, OSHA 1910.29, 1926.1053, 1926.502, 1910.140



### Ladder System Label

**019-12031**

- High visibility green color stands out
- Easily track product inspection
- Corrosion-resistant stainless steel
- Includes attachment wire

### Top Bracket Assembly (4-Person)

**019-12024**

- Energy absorbing, powder coated, stainless steel head
- Corrosion-resistant post
- 3,600 lb. single user anchor point
- All mounting hardware included
- Weight Capacity ANSI 130-310 lbs., OSHA 420 lbs.
- System Capacity up to 1240 lbs.
- ANSI A14.3, OSHA 1910.29, 1926.1053, 1926.502, 1910.140

#### Top Bracket Assembly (4-Person) Options

PART NUMBER Galvanized Steel	PART NUMBER Stainless Steel
019-12024	022-12104



### Bottom Bracket Assembly

**019-12025**

- Corrosion-resistant post
- Spring loaded tensioner adjusts for conditions
- All mounting hardware included
- Weight Capacity ANSI 130-310 lbs., OSHA 420 lbs.
- System Capacity up to 1240 lbs.
- ANSI A14.3, OSHA 1910.29, 1926.1053, 1926.502, 1910.140

#### Bottom Bracket Assembly Options

PART NUMBER Galvanized Steel	PART NUMBER Stainless Steel
019-12025	022-12105



**Intermediate Guide (90°)**

**019-12026**

- 90° angle for secure fit
- Molded rubber to protect cable
- Corrosion-resistant base
- Mounts to 1-1/8" rungs
- ANSI A14.3, OSHA 1910.29, 1926.1053, 1926.502, 1910.140

**Intermediate Guide (90°) Options**

PART NUMBER Galvanized Steel	PART NUMBER Stainless Steel
019-12026	022-12106



**Intermediate Guide (Straight)**

**019-12027**

- Straight for easy access
- Molded rubber to protect cable
- Corrosion-resistant base
- Mounts to 1-1/8" rungs
- ANSI A14.3, OSHA 1910.29, 1926.1053, 1926.502, 1910.140

**Intermediate Guide (Straight) Options**

PART NUMBER Galvanized Steel	PART NUMBER Stainless Steel
019-12027	022-12107



**U-Bolts**

**019-12028**

- 2 pieces per pack
- Use with 019-12029 nuts

**U-Bolts Options**

PART NUMBER Zinc Plated Steel	PART NUMBER Stainless Steel
019-12028	022-12108



**Extended U-Bolt (Adjustable SRL Ladder Anchor)**

**022-12153**

- Use with 019-12029 nuts and 022-12152 SRL Ladder Anchor Backer Bracket
- For installation of the Adjustable SRL Ladder Anchor Systems (022-12146 and 022-12147)

**Nuts (2 Piece Set)**

**019-12029**

- 2 pieces per pack
- Use with 019-12028 U-bolts

**Nuts (2 Piece Set) Options**

PART NUMBER Plated Steel	PART NUMBER Stainless Steel
019-12029	022-12109





**Backer Bracket**  
**019-12030**

- Corrosion-resistant steel

**Backer Bracket Options**

PART NUMBER Galvanized Steel	PART NUMBER Stainless Steel
019-12030	022-12110



**SRL Ladder Anchor Backer Bracket**  
**022-12152**

- Corrosion-resistant galvanized steel
- Use with 019-12029 nuts and 022-12153 Extended U-Bolts
- For installation of the Adjustable SRL Ladder Anchor Systems (022-12146 and 022-12147)



**20' Cable Assembly**  
**019-12012**

- 3/8" corrosion-resistant cable
- Steel thimble to protect cable eye
- Pre-swaged termination for added protection
- Custom lengths also available

**Cable Assembly Options**

PART NUMBER Galvanized Steel	PART NUMBER Stainless Steel	Length
019-12012	022-12136	20 ft.
019-12013	022-12137	30 ft.
019-12014	022-12138	40 ft.
019-12015	022-12139	50 ft.
019-12016	022-12140	60 ft.
019-12017	022-12141	70 ft.
019-12018	022-12142	80 ft.
019-12019	022-12143	90 ft.
019-12020	022-12144	100 ft.

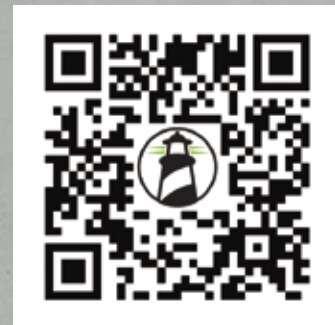

**INTERESTED IN  
THE NEWEST RELEASES  
FOR LADDER CLIMB  
SYSTEMS?**

Scan this code to view them now!







# CONFINED SPACE

No need to limit your work capacity when the workspace is confined. Designed to get you in easily and out safely, our dedicated confined space program supports entry and exit from utility manholes, silos, wells, sewers, storage containers, pits, pipelines and tunnels—all while working comfortably in between.



## TRIPOD KITS

Our confined space tripod kits serve as the support element for entry/exit into confined spaces as well as for rescue. The kits provide an anchorage for fall protection, work positioning and personnel lifts. Kits are durable yet lightweight with quick, easy setup.



## DEVICES

Selection of confined space devices including 3-way units, personnel winches and material winches used with our Safewaze tripods.



## ACCESSORIES

Assortment of commonly utilized components that work with our tripod kits and devices which expand the capability of your confined space system.



## COMPONENTS

Listing of critical replacement parts and components used in the confined space program.



## 10' TECH TRIPOD KIT: 65' PERSONNEL WINCH, 65' 3-WAY

022-11034

The 10' Tech Tripod Kit: 65' Personnel Winch, 65' 3-Way is our premium tripod with multiple configurations to fit a wide variety of work zones. The massive stance adjusts up to 18' to cover confined space, trenches, bridges, mines, rescue, inspections and more. The unique design allows use in over-edge scenarios such as cliffs or vertical walls.

- Lightweight yet durable aluminum construction
- Quick setup with easy height and diameter adjustment
- Multiple stance options, including over an edge
- [1] Centered 360° captive eye anchor
- [6] Additional 5,000 lb. anchor points
- Multi-surface steel feet with rubber pads
- Minimum Breaking Strength: 5,000 lbs.
- Weight Capacity ANSI 130-310 lbs., OSHA 420 lbs.
- Material Capacity up to 620 lbs.
- ANSI Z359.18-2017 Type T, Z359.4-2013, Z117.1-2022, OSHA 1910.140, 1926.502 (tripod only standards)\*
- Equipped with:
  - 65' 3-Way system for fall protection
  - 65' Personnel winch safely moves workers
  - [2] Aluminum pulleys
  - [2] Steel carabiners
  - [2] Universal mounting brackets
  - Safety chain and quick link
  - Heavy-duty storage bag with wheels, handles, padding and pockets



Secure Foundation



Pulley System



Personnel Winch



3-Way Device

*\*Refer to specific device for device standards.*

**10' Tech Tripod Kit: 65' Material Winch, 65' 3-Way**  
**022-11035**



- Equipped with:
  - 65' 3-Way system for fall protection
  - 65' Material winch efficiently moves gear
  - [2] Aluminum pulleys
  - [2] Steel carabiners
  - [2] Universal mounting brackets
  - Safety chain and quick link
  - Heavy-duty storage bag
- Same features, specs and standards as 022-11034

**10' Tech Tripod Kit: 65' Material Winch**  
**022-11037**



- Equipped with:
  - 65' Material winch efficiently moves gear
  - Aluminum pulley
  - Steel carabiner
  - Universal mounting bracket
  - Safety chain and quick link
  - Heavy-duty storage bag
- Same features, specs and standards as 022-11034

**10' Tech Tripod Kit: 65' 3-Way**  
**022-11036**



- Equipped with:
  - 65' 3-Way system for fall protection
  - Aluminum pulley
  - Steel carabiner
  - Universal mounting bracket
  - Safety chain and quick link
  - Heavy-duty storage bag
- Same features, specs and standards as 022-11034

**10' Tech Tripod Complete**  
**022-11033**



- Equipped with:
  - [2] Steel steps with detent pins for easy removal and adjustability to reach anchor points
  - Perimeter warning line to prevent fall hazards
  - Safety chain and quick link
  - Heavy-duty storage bag
- Same features, specs and standards as 022-11034

**10' Tech Tripod Kit Basic**  
**022-11029**



- Equipped with:
  - Safety chain and quick link
  - Heavy-duty storage bag
- Same features, specs and standards as 022-11034

## 7' ADJUSTABLE TRIPOD KIT: 65' PERSONNEL WINCH, 65' 3-WAY 019-11004

The 7' Adjustable Tripod Kit with 65' 3-Way Device and 65' Personnel Winch offers quick setup and hassle-free, versatile use for both support in confined space as well as rescue or evacuation. Lightweight yet durable construction provides anchorage for fall protection, work positioning and personnel riding systems.



- Lightweight aluminum construction
- Quick setup with easy height adjustment
- Two pulleys for use with multiple devices
- Equipped with:
  - 65' 3-Way system for fall protection
  - 65' Personnel winch to move workers
- Two additional 5,000 lb. anchor points
- Secure rubber foot pads with optional soft terrain edge
- Durable bag, safety chain and quick link
- Minimum Breaking Strength: 5,000 lbs.
- Weight Capacity ANSI 130-310 lbs.
- Material Capacity up to 620 lbs.
- ANSI Z117.1-2022, Z359.4-2013, OSHA 1926.502, 1910.140 (tripod only standards)\*



Secure Foundation



Pully System



Personnel Winch



3-Way Device

*\*Refer to specific device for device standards.*



**7' Adjustable Tripod Kit:**  
65' Material Winch, 65' 3-Way  
**019-11003**

- Equipped with:
  - 65' 3-Way system for fall protection
  - 65' Material winch efficiently moves gear
- Same features, specs and standards as 019-11004



**7' Adjustable Tripod Kit:**  
65' 3-Way  
**019-11002**

- Equipped with:
  - 65' 3-Way system for fall protection
- Same features, specs and standards as 019-11004



**7' Adjustable Tripod Kit:**  
65' Material Winch  
**019-11001**

- Equipped with:
  - 65' Material winch efficiently moves gear
- Same features, specs and standards as 019-11004



**7' Adjustable Tripod Kit:**  
65' Personnel Winch  
**021-11026**

- Equipped with:
  - 65' Personnel winch to move workers
- Same features, specs and standards as 019-11004



**7' Adjustable Tripod**  
**019-11000**

- Tripod with bag only
- Same features, specs and standards as 019-11004



**NOTE:** Matching bracket 019-11010 must be installed on tripod before mounting (not included).

## 65' 3-WAY SYSTEM, UNIVERSAL MOUNT

019-11005

The 65' 3-Way System with universal mounting bracket is designed for easy use in confined space. This multi-function device serves as the support element, provides fall protection as a Class 1 SRL and facilitates rescue or evacuation.

- Durable aluminum housing
- 6:1 gear ratio
- Easily stored, dual-function crank
- Convenient carrying handle
- Weight Capacity ANSI 130-310 lbs., OSHA 420 lbs.
- Max Operation Force: 30 lbs.
- Minimum Breaking Strength: 3,600 lbs.
- ANSI Z359.14-2021, Z359.4-2013, OSHA 1926.502, 1910.66, 1910.140

### 3-Way System, Universal Mount Sizes

Part Number	Description
019-11005	65' 3-Way System, Universal Mount
019-11015	120' 3-Way System, Universal Mount



## 115' Personnel Winch

019-11008

- Plastic cable shroud
- Free-wheel mode
- 6:1 gear ratio
- Convenient carrying handle
- Weight Capacity ANSI 130-310 lbs.
- Max Operation Force: 30 lbs.
- Minimum Breaking Strength: 3,600 lbs.
- ANSI Z359.4-2013, Z117.1-2016, OSHA 1926.502, 1910.140, 1926.21

### Personnel Winch Sizes

Part Number	Description
019-11008	115' Personnel Winch
019-11007	65' Personnel Winch



## 65' Material Winch

019-11009

- Corrosion-resistant steel cable
- Long-lasting powder-coated housing
- Durable steel components
- Comfortable plastic handle grip
- Material Capacity up to 620 lbs.
- ANSI Z117.1-2016, OSHA 1910.146



## 30" RESCUE & RETRIEVAL ASSEMBLY

020-11020

The 30" Rescue & Retrieval Assembly is highly versatile for use in suspension, rescue and evacuation or confined space applications. It can be used with full body harnesses equipped with retrieval shoulder D-rings or with our 020-11019 Bosun Seat.

- Rigid spacer maintains strap distance
- High-strength polyester webbing
- Protective label cover
- Minimum Breaking Load: 5,000 lbs.
- ANSI Z359.4, A10.32, OSHA 1910.66, 1926.502



## Bosun Seat

020-11019

- Rugged multi-ply, sealed wood seat
- Safety strap assembly adds security
- Working Load Limit: 5,000 lbs.
- OSHA 1910.66, 1926.502



The **Bosun Seat** is designed for safety and comfort in suspension or work positioning applications including confined space. Built with two separate D-ring attachment points for versatility in the mounting configuration. Mount top D-rings to the personnel rated winch or use the 020-11020 **Rescue & Retrieval Assembly** between the seat and the device for more user freedom and mobility.



**Forged D-Ring Attachments**



**Tripod Step  
(10' Tripod)  
022-11030**

- Improved reach to tripod anchor points
- Protected steel with powder coating
- Secures to 10' tech tripod leg with detent pin



**Perimeter Warning Line  
(10' Tripod)  
022-11031**

- Hi-vis green warning line to prevent fall hazards
- Webbing threads easily through brackets
- Built-in adjuster tightens webbing for secure fit
- Brackets snap onto tripod legs



**Tripod Tie-Back Line  
023-11039**

- 30' durable 7/16" Kernmantle rope
- Easy positioning rope adjuster
- For use with 10' Tripod in over-edge scenarios
- Minimum Breaking Strength: 5,000 lbs.
- Weight Capacity ANSI 130-310 lbs., OSHA 420 lbs.
- ANSI Z359.4-2013, Z117.1-2022, OSHA 1910.140, 1926.502



**Heavy Duty Duffle Bag  
019-9007**

- Water repellent construction
- Heavy duty zippers
- Rugged reinforcement with nylon straps
- Top carry handles
- Exterior storage pocket



**Heavy Duty Tripod Bag  
019-9008**

- Water repellent construction
- Heavy duty zippers
- Handles on both ends
- Easy-to-carry dual shoulder straps



**10' Tech Tripod Bag  
022-11032**

- Heavy duty with reinforced ends and bottom
- Padded shoulder carrying strap
- Multiple carrying handles
- Convenient travel wheels
- Clearly labeled component pockets





### Aluminum Tripod Pulley

**020-11025**

- Easily attaches to tripod head with rated carabiner
- Max use with 5/8" rope or 7/32" cable
- Working Load Limit: 3,372 lbs.



### Universal Tripod Bracket

**019-11010**

- Steel bracket, backer and detent pin
- All fasteners included
- Matching bracket must be installed on device before mounting



### Tripod Pulley

**FS970-PK**

- Aluminum pulley wheel
- Steel cable guide
- Mounting bolt with pin



### Tripod Replacement Chain

**019-11017**

- Durable steel chain
- Length: 9.5'
- Quick link sold separately



### Tripod Quick Link

**019-11018**

- Corrosion-resistant zinc-plated steel
- Secure screw lock gate



### Detent Pin

**020-11022**

- Used to secure tripod legs in desired stance
- Fits 7' Adjustable Tripod and 10' Tech Tripod



**INTERESTED IN THE  
NEWEST RELEASES  
FOR CONFINED SPACE?**

Scan this code to view them now!





# RESCUE

Every second counts in an emergency rescue situation. Preparation is key, so our experts will help you plan ahead and select the right equipment to have on hand, ready exactly when you need it.



## DESCENT KITS

Comprehensive yet compact controlled descent systems that are easy to set up in an emergency evacuation for both assisted and unassisted descent.



## RESCUE KITS

A range of options to help a fallen worker quickly in a variety of scenarios. From our basic rescue assist kit to rescue systems/kits with both descent and lifting capabilities.



## TRAUMA RELIEF

Suspension trauma relief provides rescue workers valuable time needed to properly rescue a worker after a fall.



## LADDERS

Fast and easy methods of rescue while only requiring minimal advanced training. An ideal low-cost, proven rescue solution.



## COMPONENTS

Essential accessories, replacement parts and individual components for descent and rescue kits.

## 50' EVACUATION/DESCENT SYSTEM

022-6051

The Evacuation/Descent System is a comprehensive yet compact kit that is easy to set up in an emergency evacuation. Lightweight device allows for assisted or unassisted descent with built-in features for added control and all the necessities packed for long-term storage.

- Dual brake pad with 1:8.2 gear ratio
- Bidirectional for consecutive descent
- Integral belays reduce descent speed
- Built-in rope lock for added control
- Weight Capacity 1-person 110-310 lbs., 2-person up to 620 lbs.
- ANSI Z359.4-2013, OSHA 1910.140, 1926.502
- Accessories included:
  - Low stretch ANSI compliant rope with captive eye
  - Carabiner for harness connection
  - 3' reinforced cross arm strap anchor
  - 18" rope protector for longevity
  - Heavy duty, water repellent, hi-vis duffle



### Evacuation/Descent Systems

Part Number	Description
022-6051	50' Evacuation/Descent System
022-6052	100' Evacuation/Descent System



## 200' Evacuation/Descent System

### 022-6053

- Dual brake pad with 1:8.2 gear ratio
  - Bidirectional for consecutive descent
  - Integral belays reduce descent speed
  - Built-in rope lock for added control
  - Weight Capacity 1-person 110-310 lbs., 2-person up to 620 lbs.
  - ANSI Z359.4-2013, OSHA 1910.140, 1926.502
- Accessories included:
    - Low stretch ANSI compliant rope with captive eye
    - Carabiner for harness connection
    - 3' reinforced cross arm strap anchor
    - 36" rope protector for longevity
    - Heavy duty, backpack-style water repellent gear bag

### Evacuation/Descent Systems

PART NUMBER	DESCRIPTION
022-6053	200' Evacuation/Descent System
022-6054	300' Evacuation/Descent System
022-6055	400' Evacuation/Descent System
022-6056	500' Evacuation/Descent System



## 150' RESCUE/DESCENT KIT

022-6061

The Rescue/Descent Kit includes lots of extras with both descent and lifting capabilities making it ideal for rescue situations. Lightweight device allows for assisted or unassisted descent with tons of features and accessories packed for secure, long-term storage.

- Lifting wheel aids in disconnection for rescue
- Dual brake pad with 1:8.2 gear ratio
- Bidirectional for consecutive descent
- Integral belays reduce descent speed
- Built-in rope lock for added control
- Weight Capacity 1-person 110-310 lbs., 2-person up to 620 lbs.
- ANSI Z359.4-2013, OSHA 1910.140, 1926.502
- Accessories included:
  - Low stretch ANSI compliant rope with captive eye
  - Carabiner for harness connection
  - 3' reinforced cross arm strap anchor
  - 36" rope protector for longevity
  - Pick-off pole adjusts from 4-18'
  - Rescue pole head holds carabiner open
  - Aluminum pick-off carabiner with web connector
  - Water repellent pole bag attaches to gear bag
  - Tool attachment and tether to secure rescue pole
  - Heavy duty, backpack-style water repellent gear bag



### Rescue/Descent Kits

Part Number	Description
022-6061	150' Rescue/Descent Kit
022-6062	200' Rescue/Descent Kit
022-6063	300' Rescue/Descent Kit
022-6064	400' Rescue/Descent Kit
022-6065	500' Rescue/Descent Kit



**50' Rescue/Descent System**  
**022-6059**

- Lifting wheel aids in disconnection for rescue
- Dual brake pad with 1:8.2 gear ratio
- Bidirectional for consecutive descent
- Integral belays reduce descent speed
- Built-in rope lock for added control
- Weight Capacity  
1-person 110-310 lbs.,  
2-person up to 620 lbs.
- ANSI Z359.4-2013,  
OSHA 1910.140,  
1926.502
- Accessories included:
  - Low stretch ANSI compliant rope with captive eye
  - Carabiner for harness connection
  - 3' reinforced cross arm strap anchor
  - 18" rope protector for longevity
  - Heavy duty, water repellent, hi-vis duffle



**Rescue Assist Kit**  
**018-6000**

- Ratchet assembly rated to 3,000 lbs. with carabiners
- 10' abrasion-resistant kernmantle rope assembly with carabiner
- Edge protector for added security
- Secure, adjustable sling assembly
- Cable clamp rated to 1,000 lbs.
- Durable, water repellent bag
- Weight Capacity ANSI 130-310 lbs., OSHA 420 lbs.

**Rescue/Descent Systems**

PART NUMBER	DESCRIPTION
022-6059	50' Rescue/Descent System
022-6060	100' Rescue/Descent System

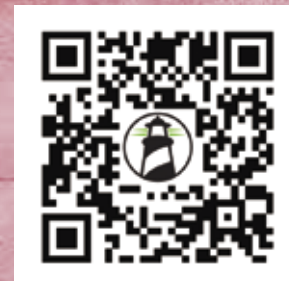

**INTERESTED IN THE  
NEWEST RELEASES  
FOR RESCUE?**

Scan this code to view them now!





**22' Rescue Ladder**  
**020-6041**

- Protective, water repellent carry bag with reflective trim
- High abrasion polyester webbing
- 10" wide reinforced ladder rung
- [1] steel carabiner
- Minimum Breaking Strength: 3,600 lbs.
- Weight Capacity ANSI 130-310 lbs., OSHA 420 lbs.
- OSHA 1910.66, 1926.502



**22' Rescue Ladder with Belay**  
**020-6042**

- 28' abrasion-resistant kernmantle rope
- Aluminum progress capture device
- Protective, water repellent carry bag with reflective trim
- High abrasion polyester webbing
- 10" wide reinforced ladder rung
- [3] steel carabiners
- Minimum Breaking Strength: 3,600 lbs.
- Weight Capacity ANSI 130-310 lbs., OSHA 420 lbs.
- OSHA 1910.66, 1926.502







## QUICK-ADJUST TRAUMA RELIEF

022-6047

Quick-Adjust Trauma Relief is easy to attach and simple to deploy after a fall to relieve pressure and promote circulation until rescue. Versatile adjustment to better fit workers of all heights and allow easier movement for proper blood flow.

- Adjustable once deployed for proper step length
- Easily connects to most harnesses in seconds
- Hi-vis webbing step for visibility in fall event
- Packs attach on each hip with versatility to place adjuster on preferred side
- Weight Capacity ANSI 130-310 lbs., OSHA 420 lbs.



## Suspension Trauma Steps

FS902

- 6' overall strap length
- Multi-step system for versatility
- Durable web construction
- Quickly attaches to most harnesses
- Simple connection at dorsal D-ring
- Weight Capacity up to 400 lbs.



### Suspension Trauma

A fallen worker in a harness experiences restricted circulation while hanging. Serious or fatal trauma can result within minutes, so a rescue plan is critical.

Quick-Adjust Trauma Relief and Suspension Trauma Steps allow the worker to stand up in the harness, restoring circulation until help arrives.

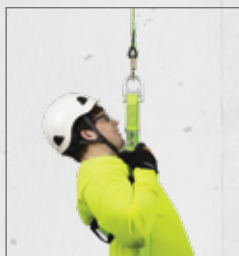

## RESCUE ASSIST SLING

022-6069

The Rescue Assist Sling is simple to use with a conscious worker in most rescue scenarios, especially confined space.

- Lightweight and easy to deploy
- Efficient wrap-around style with self-locking hook
- Universal sizing adjusts to fit most body types
- Padding provides comfort where it's needed
- Minimum Breaking Strength: 5,000 lbs.
- Weight Capacity ANSI 130-310 lbs., OSHA 420 lbs.



## Web Connector (for rescue system)

022-6070

- Ideal for use in pick-off rescue situations
- Built with high strength webbing for durability
- Loop attachment points for ease of use
- Designed to connect with most carabiners
- Minimum Breaking Strength: 5,000 lbs.



## Aluminum Carabiner (for rescue system)

022-6071

- Lightweight aluminum construction
- Highly visible red color for easier connection
- Anodized surface treatment for added protection
- 3,600 lb. double action twist lock gate
- For use with the 022-6073 rescue pole
- Minimum Breaking Strength: 5,000 lbs.
- Weight Capacity ANSI 130-310 lbs., OSHA 420 lbs.
- ANSI Z359.12, OSHA 1926.502



**Rescue Pole Head**  
**022-6072**

- Ideal for use in pick-off rescue situations
- Screw-on base protected with shrink tube
- Holds carabiner open and snaps shut once connection is secured
- For use with the 022-6073 rescue pole



**4-18' Rescue Pole Kit**  
**022-6073**

- Telescoping pole extends from 4-18'
- Lightweight for easier maneuverability
- Pole head bracket includes carabiner clamp and anchor hook
- Accessories included:
  - Tool attachment and tether to secure rescue pole
  - Protective water repellent bag for organization



**Rescue Gear Bag**  
**023-9087**

- Hi-vis material for easy spotting during an emergency
- Heavy duty construction with water repellent material
- Reinforced bottom for long-term storage
- Labeled pockets keep kit organized for rapid rescue
- Clips attach pole bag to keep kit together
- Integrated backpack straps for hands-free transport
- Padded panel for added comfort



**Rescue Pick-off Strap**  
**023-6074**

- Adjustable 14"-38" for optimal positioning
- Connects between rescuer and fallen worker
- Soft loop on anchor point end
- D-ring adjuster on load end
- Elastic keepers stow excess webbing
- For use with any ANSI Z359.12 carabiner
- Slip Load 2,500 lbs.
- Weight Capacity ANSI 130-310 lbs., OSHA 420 lbs.



# TOOL LANYARDS

Dropped objects are more than just a headache. In addition to lost work time, replacement costs and structural damage, the force of the object can cause severe injury or death to people below. Good news: falling objects are easily preventable with specific equipment designed for comfort and practical use in the field.

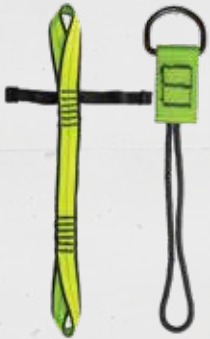

## TOOL ATTACHMENTS

A tight grip is critical for dropped object prevention. Quickly secure the tools you need for the job with D-ring, choker and cinch style attachments.



## TOOL TETHERS

Prevent injury, lost time and costly replacements with a secure connection between you and your tool. Available in elastic and fixed lengths.



## ANCHOR POINTS

Keep your tools both close at hand so you can work efficiently and securely attached so you can prevent dropped objects.



### 5 LB. ARC FLASH TOOL ANCHOR 022-10006

The 5 lb. Arc Flash Tool Anchor is uniquely built for complete security in extreme environments with arc flash resistant webbing, stitching and D-ring. Quickly and securely cinches on any convenient location on any harness. For use with most tool tethers.



- Durable construction
- Versatile choke style installation
- 40Cal rated aramid webbing
- Kevlar stitching
- Military grade plastic D-ring
- For use on tools up to 5 lbs.
- ANSI/ISEA 121-2018, ASTM F887

#### 5 lb. Arc Flash Tool Anchor Options

Part Number	Description
022-10006	5 lb. Arc Flash Tool Anchor
022-10007	5 lb. Arc Flash Tool Anchor: 50 Pack



### 5 lb. Wrist Tool Anchor SW424

- Comfortable padding
- Velcro adjustment to fit most sizes
- For use on tools up to 5 lbs.
- Width: 1.75"
- ANSI/ISEA 121-2018



### 35 LB. MEDIUM DUTY CINCH TOOL ATTACHMENT (WITH STABILIZATION TABS)

SW406

The 35 lb. Medium Duty Cinch Tool Attachment with Stabilization Tabs has a pass-through loop on one end for easy installation on a wide variety of tools with a web loop on the other end for your tool tether. Versatile stabilization wings are taped to the tool to separate the attachment from moving parts.

- Durable construction
- Versatile stabilization wings
- Dual loop connection points
- For use on tools up to 35 lbs.
- Length: 15"
- ANSI/ISEA 121-2018

#### 35 lb. Medium Duty Cinch Tool Attachment Options

PART NUMBER	DESCRIPTION
SW406	35 lb. Medium Duty Cinch Tool Attachment (with Stabilization Tabs)
SW404	35 lb. Medium Duty Cinch Tool Attachment (No Tabs)



### 5 lb. D-Ring Tool Attachment: 10 Pack

SW402

- Webbing with steel D-ring
- Use with the 2" Yellow Tool Tape
- For use on tools up to 5 lbs.
- Length: 3.5"
- ANSI/ISEA 121-2018



### 5 lb. Elasticated Tool Attachment: 3 Pack

SW425

- Swivel D-ring for easy attachment
- Cord lock for secure grip on tools
- For use on tools up to 5 lbs.
- Length: 11"
- ANSI/ISEA 121-2018



### 15 lb. D-Ring Tool Attachment: 10 Pack

SW408

- Large D-ring for easy attachment
- For use on tools up to 15 lbs.
- Length: 8"
- ANSI/ISEA 121-2018

**1" Blue Tool Tape**  
**SW423**

- Self-adhesive, no heat required
- Also used for choker style attachments
- For use on tools up to 2 lbs.
- Length: 9'
- ANSI/ISEA 121-2018

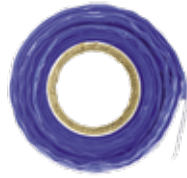

**2" Yellow Tool Tape**  
**SW422**

- Self-adhesive, no heat required
- Also used for choker style attachments
- For use on tools up to 5 lbs.
- Length: 9'
- ANSI/ISEA 121-2018



**Yellow Tool Tape Options**

PART NUMBER	DESCRIPTION
SW422	2" Yellow Tool Tape
SW422-10	2" Yellow Tool Tape: 10 Pack

**2 lb. Small Tool Ring:**  
**25 Pack**  
**SW426**

- Plated steel ring
- For use on tools up to 2 lbs.
- Size: 0.75"
- ANSI/ISEA 121-2018



**2 lb. Large Tool Ring:**  
**25 Pack**  
**SW428**

- Plated steel ring
- For use on tools up to 2 lbs.
- Size: 1.5"
- ANSI/ISEA 121-2018



**80 lb. Heavy Duty Cinch**  
**Tool Attachment**  
**(with Stabilization Tabs)**  
**SW407**

- Durable construction
- Versatile stabilization wings
- Dual loop connection points
- For use on tools up to 80 lbs.
- Length: 25"
- ANSI/ISEA 121-2018





**15 LB. ELASTICATED TOOL TETHER:  
CARABINER, CINCH**

**SW438**

The 15 lb. Elasticated Tool Tether features a cinch loop with a cord lock on one end and twist lock carabiner on the other. The elasticated construction creates a greater range of use, making this one of the most versatile and widely used tether solutions.

- Increased range and energy absorption
- Choker end with cord lock
- Aluminum carabiner
- For use on tools up to 15 lbs.
- Length: 36" to 58"
- ANSI/ISEA 121-2018



**5 lb. 12" Tool Tether:  
10 Pack**

**SW416**

- Swivel clamp connectors to prevent entanglement
- For use on tools up to 5 lbs.
- Length: 12"
- ANSI/ISEA 121-2018



**5 lb. 24" Tool Tether:  
10 Pack**

**SW417**

- Swivel clamp connectors to prevent entanglement
- For use on tools up to 5 lbs.
- Length: 24"
- ANSI/ISEA 121-2018



**5 lb. Coil Tool Tether**

**SW411**

- Coated steel cable for durability
- Aluminum carabiners
- For use on tools up to 5 lbs.
- Length: 14" to 68"
- ANSI/ISEA 121-2018



**2 lb. Coil Tool Tether**

**SW414**

- Coated steel cable for durability
- Aluminum carabiners
- For use on tools up to 2 lbs.
- Length: 28" to 74"
- ANSI/ISEA 121-2018





### 15 lb. Elasticated Tool Lanyard

**FS8016**

- Increased range and energy absorption
- Choker end with cord lock
- Steel carabiner
- For use on tools up to 15 lbs.
- Length: 36" to 58"



### 15 lb. Elasticated Tool Tether: 2 Carabiners

**SW436**

- Increased range and energy absorption
- Aluminum carabiners
- For use on tools up to 15 lbs.
- Length: 31" to 61"
- ANSI/ISEA 121-2018



### 5 lb. Arc Flash Elasticated Tool Tether: Carabiner, Cinch

**022-10002**

- 40Cal rated aramid web for electric and high heat
- Increased range and energy absorption
- Choker end with cord lock
- Aluminum carabiner
- For use on tools up to 5 lbs.
- Length: 39" to 62"
- ANSI/ISEA 121-2018, ASTM F887



### 5 lb. Arc Flash Elasticated Tool Tether: 2 Carabiners

**022-10003**

- 40Cal rated aramid web for electric and high heat
- Increased range and energy absorption
- Aluminum carabiners
- For use on tools up to 5 lbs.
- Length: 32" to 53"
- ANSI/ISEA 121-2018, ASTM F887



### 15 lb. Arc Flash Elasticated Tool Tether: Carabiner, Cinch

**022-10004**

- 40Cal rated aramid web for electric and high heat
- Increased range and energy absorption
- Choker end with cord lock
- Aluminum carabiner
- For use on tools up to 15 lbs.
- Length: 39" to 62"
- ANSI/ISEA 121-2018, ASTM F887



### 15 lb. Arc Flash Elasticated Tool Tether: 2 Carabiners

**022-10005**

- 40Cal rated aramid web for electric and high heat
- Increased range and energy absorption
- Aluminum carabiners
- For use on tools up to 15 lbs.
- Length: 32" to 58"
- ANSI/ISEA 121-2018, ASTM F887



**35 lb. Medium Duty Elasticated Tool Tether**  
**SW431**

- Internal POY energy absorber
- Increased range and energy absorption
- Choker style end for direct connection
- Swivel aluminum carabiner
- For use on tools up to 35 lbs.
- Length: 52" to 66"
- ANSI/ISEA 121-2018



**35 lb. Medium Duty Elasticated Tool Tether: 2 Carabiners**  
**SW432**

- Internal POY energy absorber
- Increased range and energy absorption
- Swivel aluminum carabiners
- For use on tools up to 35 lbs.
- Length: 50" to 62"
- ANSI/ISEA 121-2018



**80 lb. Heavy Duty Elasticated Tool Tether: Loop**  
**SW433**

- Internal POY energy absorber
- Increased range and energy absorption
- Choker style end for direct connection
- Swivel aluminum carabiner
- For use on tools up to 80 lbs.
- Length: 66.5" to 80.5"
- ANSI/ISEA 121-2018



**80 lb. Heavy Duty Elasticated Tool Tether**  
**SW434**

- Internal POY energy absorber
- Increased range and energy absorption
- Swivel aluminum carabiners
- For use on tools up to 80 lbs.
- Length: 64" to 80.5"
- ANSI/ISEA 121-2018











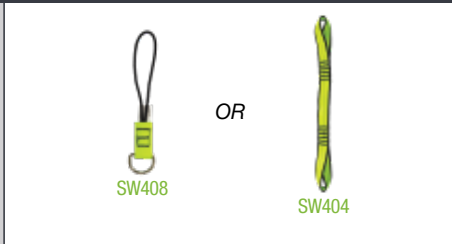

**INTERESTED IN THE  
NEWEST RELEASES  
FOR TOOL LANYARDS?**

Scan this code to view them now!

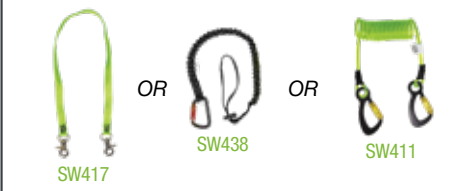
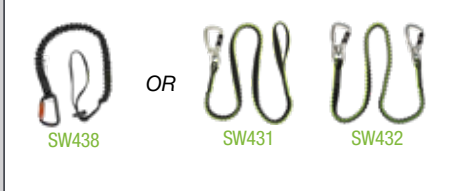
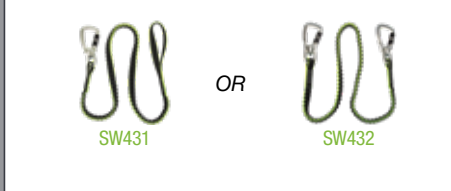

# SAMPLE CONNECTION OPTIONS

5 lb. TOOLS	15 lb. TOOLS	35 lb. TOOLS
 <p style="text-align: center;">+</p>	 <p style="text-align: center;">+</p>	 <p style="text-align: center;">+</p>
TOOL ATTACHMENT		
 <p style="text-align: center;">+</p>	 <p style="text-align: center;">+</p>	 <p style="text-align: center;">+</p>
TOOL TETHER		
 <p style="text-align: center;">=</p>	 <p style="text-align: center;">=</p>	 <p style="text-align: center;">=</p>
		

# KITS & COMBOS

For utmost convenience and added value, these collections are grouped to meet the specific needs of an individual job or collective market. All the basic necessities are packaged together to ensure each worker is properly protected.



## PRO+ KITS

A collection of premium personal fall protection components, including a PRO+ harness, grouped to meet the needs of a specific market or job site function.



## PRO+ COMBOS

Two or more personal fall protection components, including a premium PRO+ harness, combined to properly outfit specific end users.



## PRO KITS

A collection of personal fall protection components, including a PRO harness, grouped to meet the needs of a specific market or job site function.



## PRO COMBOS

Two or more personal fall protection components, including a PRO harness, combined to properly outfit specific end users.



## V-LINE KITS

A collection of economy personal fall protection components, including a V-Line harness, grouped to meet the needs of a specific market or job site function.



## V-LINE COMBOS

Two or more personal fall protection components, including an economy V-Line harness, combined to properly outfit specific end users.

**PRO+ Kit Options**

	PART NUMBER	DESCRIPTION	HARNESS SIZE	TYPE	STORAGE	OPTION
1	FS155-S/M	PRO+ Bucket Roof Kit: FS-FLEX185-S/M Harness, FS700-50GA VLL, FS8800SP-H Absorber, FS870 Anchor	Small/Medium	Roof	Bucket	FS870 Anchor
	FS155-L/XL	PRO+ Bucket Roof Kit: FS-FLEX185-L/XL Harness, FS700-50GA VLL, FS8800SP-H Absorber, FS870 Anchor	Large/X-Large	Roof	Bucket	FS870 Anchor
	FS155-2X	PRO+ Bucket Roof Kit: FS-FLEX185-2X Harness, FS700-50GA VLL, FS8800SP-H Absorber, FS870 Anchor	2X-Large	Roof	Bucket	FS870 Anchor
2	020-3122	PRO+ Bag Roof Kit: FS-FLEX185-S/M Harn, FS700-50GA VLL, FS813 Extender, FS811-20 Strap, FS870 Anchor, FS8175 Bag	Small/Medium	Roof	Bag	FS870 Anchor
	020-3123	PRO+ Bag Roof Kit: FS-FLEX185-L/XL Harn, FS700-50GA VLL, FS813 Extender, FS811-20 Strap, FS870 Anchor, FS8175 Bag	Large/X-Large	Roof	Bag	FS870 Anchor
	020-3124	PRO+ Bag Roof Kit: FS-FLEX185-2X Harn, FS700-50GA VLL, FS813 Extender, FS811-20 Strap, FS870 Anchor, FS8175 Bag	2X-Large	Roof	Bag	FS870 Anchor

**PRO Kit Options**

	PART NUMBER	DESCRIPTION	HARNESS SIZE	TYPE	STORAGE	OPTION
1	018-3000	PRO Bag Kit: FS185-S/M Harness, FS580 Lanyard, FS902 Trauma, FS8150 Bag	Small/Medium	Compliance	Bag	Lanyard
	018-3001	PRO Bag Kit: FS185-L/XL Harness, FS580 Lanyard, FS902 Trauma, FS8150 Bag	Large/X-Large	Compliance	Bag	Lanyard
	018-3002	PRO Bag Kit: FS185-2X Harness, FS580 Lanyard, FS902 Trauma, FS8150 Bag	2X-Large	Compliance	Bag	Lanyard
	020-3090	PRO Bag Kit: FS185-3X Harness, FS580 Lanyard, FS902 Trauma, FS8150 Bag	3X-Large	Compliance	Bag	Lanyard
2	018-3003	PRO Bag Kit: FS185-S/M Harness, 018-5025 SRL, FS902 Trauma, FS8150 Bag	Small/Medium	Compliance	Bag	SRL
	018-3004	PRO Bag Kit: FS185-L/XL Harness, 018-5025 SRL, FS902 Trauma, FS8150 Bag	Large/X-Large	Compliance	Bag	SRL
	018-3005	PRO Bag Kit: FS185-2X Harness, 018-5025 SRL, FS902 Trauma, FS8150 Bag	2X-Large	Compliance	Bag	SRL

PRO Kit Options - Continued

	PART NUMBER	DESCRIPTION	HARNESS SIZE	TYPE	STORAGE	OPTION
3	FS123-XS	PRO Bag Kit: FS285-XS Harness, FS700-50 VLL, FS1120 Grab, FS560 Lanyard, FS870 Anchor, FS8175 Bag	X-Small	Compliance	Bag	FS870 Anchor
	FS123-S/M	PRO Bag Kit: FS285-S/M Harness, FS700-50 VLL, FS1120 Grab, FS560 Lanyard, FS870 Anchor, FS8175 Bag	Small/Medium	Compliance	Bag	FS870 Anchor
	FS123-L/XL	PRO Bag Kit: FS285-L/XL Harness, FS700-50 VLL, FS1120 Grab, FS560 Lanyard, FS870 Anchor, FS8175 Bag	Large/X-Large	Compliance	Bag	FS870 Anchor
	FS123-2X	PRO Bag Kit: FS285-2X Harness, FS700-50 VLL, FS1120 Grab, FS560 Lanyard, FS870 Anchor, FS8175 Bag	2X-Large	Compliance	Bag	FS870 Anchor
	FS123-3X	PRO Bag Kit: FS285-3X Harness, FS700-50 VLL, FS1120 Grab, FS560 Lanyard, FS870 Anchor, FS8175 Bag	3X-Large	Compliance	Bag	FS870 Anchor
4	FS120-XS	PRO Bucket Roof Kit: FS280-XS Harness, FS700-50GA VLL, FS560 Lanyard, FS870 Anchor	X-Small	Roof	Bucket	FS870 Anchor
	FS120-S/M	PRO Bucket Roof Kit: FS280-S/M Harness, FS700-50GA VLL, FS560 Lanyard, FS870 Anchor	Small/Medium	Roof	Bucket	FS870 Anchor
	FS120-L/XL	PRO Bucket Roof Kit: FS280-L/XL Harness, FS700-50GA VLL, FS560 Lanyard, FS870 Anchor	Large/X-Large	Roof	Bucket	FS870 Anchor
	FS120-2X	PRO Bucket Roof Kit: FS280-2X Harness, FS700-50GA VLL, FS560 Lanyard, FS870 Anchor	2X-Large	Roof	Bucket	FS870 Anchor
	FS120-3X	PRO Bucket Roof Kit: FS280-3X Harness, FS700-50GA VLL, FS560 Lanyard, FS870 Anchor	3X-Large	Roof	Bucket	FS870 Anchor
5	FS120-3-XS	PRO Bucket Roof Kit: FS280-XS Harness, FS700-50GA VLL, FS560-3 Lanyard, FS870 Anchor	X-Small	Roof	Bucket	FS870 Anchor
	FS120-3-S/M	PRO Bucket Roof Kit: FS280-S/M Harness, FS700-50GA VLL, FS560-3 Lanyard, FS870 Anchor	Small/Medium	Roof	Bucket	FS870 Anchor
	FS120-3-L/XL	PRO Bucket Roof Kit: FS280-L/XL Harness, FS700-50GA VLL, FS560-3 Lanyard, FS870 Anchor	Large/X-Large	Roof	Bucket	FS870 Anchor
	FS120-3-2X	PRO Bucket Roof Kit: FS280-2X Harness, FS700-50GA VLL, FS560-3 Lanyard, FS870 Anchor	2X-Large	Roof	Bucket	FS870 Anchor
	FS120-3-3X	PRO Bucket Roof Kit: FS280-3X Harness, FS700-50GA VLL, FS560-3 Lanyard, FS870 Anchor	3X-Large	Roof	Bucket	FS870 Anchor

## PRO Kit Options - Continued

	PART NUMBER	DESCRIPTION	HARNESS SIZE	TYPE	STORAGE	OPTION
6	019-3024	PRO Bucket Roof Kit: FS185-S/M Harness, 018-7005 VLL, FS870 Anchor	Small/Medium	Roof	Bucket	FS870 Anchor
	019-3025	PRO Bucket Roof Kit: FS185-L/XL Harness, 018-7005 VLL, FS870 Anchor	Large/X-Large	Roof	Bucket	FS870 Anchor
	019-3026	PRO Bucket Roof Kit: FS185-2X Harness, 018-7005 VLL, FS870 Anchor	2X-Large	Roof	Bucket	FS870 Anchor
7	FS-ROOF-X-S/M	PRO Bucket Roof Kit: FS280-S/M Harness, 018-7005 VLL, FS870 Anchor	Small/Medium	Roof	Bucket	FS870 Anchor
	FS-ROOF-X-L/XL	PRO Bucket Roof Kit: FS280-L/XL Harness, 018-7005 VLL, FS870 Anchor	Large/X-Large	Roof	Bucket	FS870 Anchor
	FS-ROOF-X-2X	PRO Bucket Roof Kit: FS280-2X Harness, 018-7005 VLL, FS870 Anchor	2X-Large	Roof	Bucket	FS870 Anchor
8	020-3114	PRO Bag Roof Kit: FS185-XS Harn, FS700-50 VLL, FS1120 Grab, FS88560-E Lanyard, FS870 Anchor, FS8175 Bag	X-Small	Roof	Bag	FS870 Anchor
	020-3115	PRO Bag Roof Kit: FS185-S/M Harn, FS700-50 VLL, FS1120 Grab, FS88560-E Lanyard, FS870 Anchor, FS8175 Bag	Small/Medium	Roof	Bag	FS870 Anchor
	020-3116	PRO Bag Roof Kit: FS185-L/XL Harn, FS700-50 VLL, FS1120 Grab, FS88560-E Lanyard, FS870 Anchor, FS8175 Bag	Large/X-Large	Roof	Bag	FS870 Anchor
	020-3117	PRO Bag Roof Kit: FS185-2X Harn, FS700-50 VLL, FS1120 Grab, FS88560-E Lanyard, FS870 Anchor, FS8175 Bag	2X-Large	Roof	Bag	FS870 Anchor
	020-3118	PRO Bag Roof Kit: FS185-3X Harn, FS700-50 VLL, FS1120 Grab, FS88560-E Lanyard, FS870 Anchor, FS8175 Bag	3X-Large	Roof	Bag	FS870 Anchor
9	019-3049	PRO Bag Roof Kit: FS185-XS Harn, FS700-50 VLL, FS1118-DC Grab, FS88560-E Lanyard, FS870 Anchor, FS8185 Bag	X-Small	Roof	Bag	FS870 Anchor
	019-3050	PRO Bag Roof Kit: FS185-S/M Harn, FS88560-E Lanyard, FS700-50 VLL, FS1118-DC Grab, FS870 Anchor, FS8185 Bag	Small/Medium	Roof	Bag	FS870 Anchor
	019-3051	PRO Bag Roof Kit: FS185-L/XL Harn, FS88560-E Lanyard, FS700-50 VLL, FS1118-DC Grab, FS870 Anchor, FS8185 Bag	Large/X-Large	Roof	Bag	FS870 Anchor
	019-3052	PRO Bag Roof Kit: FS185-2X Harn, FS88560-E Lanyard, FS700-50 VLL, FS1118-DC Grab, FS870 Anchor, FS8185 Bag	2X-Large	Roof	Bag	FS870 Anchor

PRO Kit Options - Continued

PART NUMBER	DESCRIPTION	HARNESS SIZE	TYPE	STORAGE	OPTION	
10	FS137-XS	PRO Bag Roof Kit: FS185-XS Harness, FS700-50 VLL, FS1118-DC Grab, FS560-3 Lanyard, FS870 Anchor, FS8150 Bag	X-Small	Roof	Bag	FS870 Anchor
	FS137-S/M	PRO Bag Roof Kit: FS185-S/M Harness, FS700-50 VLL, FS1118-DC Grab, FS560-3 Lanyard, FS870 Anchor, FS8150 Bag	Small/Medium	Roof	Bag	FS870 Anchor
	FS137-L/XL	PRO Bag Roof Kit: FS185-L/XL Harness, FS700-50 VLL, FS1118-DC Grab, FS560-3 Lanyard, FS870 Anchor, FS8150 Bag	Large/X-Large	Roof	Bag	FS870 Anchor
	FS137-2X	PRO Bag Roof Kit: FS185-2X Harness, FS700-50 VLL, FS1118-DC Grab, FS560-3 Lanyard, FS870 Anchor, FS8150 Bag	2X-Large	Roof	Bag	FS870 Anchor
	FS137-3X	PRO Bag Roof Kit: FS185-3X Harness, FS700-50 VLL, FS1118-DC Grab, FS560-3 Lanyard, FS870 Anchor, FS8150 Bag	3X-Large	Roof	Bag	FS870 Anchor
11	019-3014	PRO Bag Roof Kit: FS185-S/M Harness, FS700-50 VLL, FS1120 Grab, FS88580 Lanyard, FS870 Anchor, FS8185 Bag	Small/Medium	Roof	Bag	FS870 Anchor
	019-3015	PRO Bag Roof Kit: FS185-L/XL Harness, FS700-50 VLL, FS1120 Grab, FS88580 Lanyard, FS870 Anchor, FS8185 Bag	Large/X-Large	Roof	Bag	FS870 Anchor
	019-3016	PRO Bag Roof Kit: FS185-2X Harness, FS700-50 VLL, FS1120 Grab, FS88580 Lanyard, FS870 Anchor, FS8185 Bag	2X-Large	Roof	Bag	FS870 Anchor
12	FS124-XS	PRO Bag Roof Kit: FS185-XS Harness, FS700-50GA VLL, FS560 Lanyard, FS870 Anchor, FS8150 Bag	X-Small	Roof	Bag	FS870 Anchor
	FS124-S/M	PRO Bag Roof Kit: FS185-S/M Harness, FS700-50GA VLL, FS560 Lanyard, FS870 Anchor, FS8150 Bag	Small/Medium	Roof	Bag	FS870 Anchor
	FS124-L/XL	PRO Bag Roof Kit: FS185-L/XL Harness, FS700-50GA VLL, FS560 Lanyard, FS870 Anchor, FS8150 Bag	Large/X-Large	Roof	Bag	FS870 Anchor
	FS124-2X	PRO Bag Roof Kit: FS185-2X Harness, FS700-50GA VLL, FS560 Lanyard, FS870 Anchor, FS8150 Bag	2X-Large	Roof	Bag	FS870 Anchor
	FS124-3X	PRO Bag Roof Kit: FS185-3X Harness, FS700-50GA VLL, FS560 Lanyard, FS870 Anchor, FS8150 Bag	3X-Large	Roof	Bag	FS870 Anchor
13	019-3011	PRO Bag Kit: FS185-S/M Harness, FS700-50GA VLL, FS560-3 Lanyard, FS8175 Bag	Small/Medium	Compliance	Bag	No Anchor
	019-3012	PRO Bag Kit: FS185-L/XL Harness, FS700-50GA VLL, FS560-3 Lanyard, FS8175 Bag	Large/X-Large	Compliance	Bag	No Anchor
	019-3013	PRO Bag Kit: FS185-2X Harness, FS700-50GA VLL, FS560-3 Lanyard, FS8175 Bag	2X-Large	Compliance	Bag	No Anchor



## PRO Kit Options - Continued

	PART NUMBER	DESCRIPTION	HARNESS SIZE	TYPE	STORAGE	OPTION
14	FS140-S/M	PRO Bag Kit: FS185-S/M Harness, FS590 Lanyard, FS811-6 Anchor, FS8150 Bag	Small/Medium	Compliance	Bag	FS811-6 Anchor
	FS140-L/XL	PRO Bag Kit: FS185-L/XL Harness, FS590 Lanyard, FS811-6 Anchor, FS8150 Bag	Large/X-Large	Compliance	Bag	FS811-6 Anchor
15	EX-1000-S/M	PRO Bag Kit: FS185-S/M Harness, 018-5009 SRL, FS811-3 Anchor, FS8150 Bag	Small/Medium	Compliance	Bag	SRL
	EX-1000-L/XL	PRO Bag Kit: FS185-L/XL Harness, 018-5009 SRL, FS811-3 Anchor, FS8150 Bag	Large/X-Large	Compliance	Bag	SRL
	EX-1000-2X	PRO Bag Kit: FS185-2X Harness, 018-5009 SRL, FS811-3 Anchor, FS8150 Bag	2X-Large	Compliance	Bag	SRL

## V-LINE Kit Options

	PART NUMBER	DESCRIPTION	HARNESS SIZE	TYPE	STORAGE	OPTION
	EX-3000	V-Line Bucket Roof Kit: FS99185-E Harn, FS700-50 VLL, FS1120 Grab, FS88560-E3 Lan, FS870 Anchor, FS902 Trauma	Universal	Roof	Bucket	FS870 Anchor
	019-3038	V-Line Bucket Roof Kit: FS99281-E Harness, FS700-50GA-3E VLL, FS870 Anchor	Universal	Roof	Bucket	FS870 Anchor
	FS-ROOF-E/1120	V-Line Bucket Roof Kit: FS99280-E Harness, FS700-50 VLL, FS1120 Grab, FS88860-3 Lanyard, FS870 Anchor	Universal	Roof	Bucket	FS870 Anchor
	FS-ROOF-P	V-Line Bucket Roof Kit: FS99185-E Harness, FS700-50 VLL, FS1120 Grab, FS88560-E3 Lanyard, FS870 Anchor	Universal	Roof	Bucket	FS870 Anchor
	020-3130	V-Line Bucket Roof Kit: FS99185-E Harness, FS700-50 VLL, FS1118-DC Grab, FS88560-E3 Lanyard, FS870 Anchor	Universal	Roof	Bucket	FS870 Anchor
	020-3119	V-Line Bucket Roof Kit: FS99185-E Harness, FS700-50 VLL, FS1120 Grab, FS88560-E3 Lanyard	Universal	Roof	Bucket	No Anchor
	FS120-E/1118DC	V-Line Bucket Roof Kit: FS99280-E Harness, FS700-50 VLL, FS1118-DC Grab, FS88560-E Lanyard, FS870 Anchor	Universal	Roof	Bucket	FS870 Anchor
	FS148	V-Line Bucket Roof Kit: FS99280-E Harness, FS700-50GA VLL, FS88560-E Lanyard, FS870 Anchor	Universal	Roof	Bucket	FS870 Anchor
	FS120-50	V-Line Bucket Roof Kit: FS99185-E Harness, 018-7005 VLL, FS870 Anchor	Universal	Roof	Bucket	FS870 Anchor
	FS-EX6000-Bucket	V-Line Bucket Roof Kit: FS99280-E Harness, FS700-50 VLL, FS1120 Grab, FS88560-E Lanyard, FS870 Anchor	Universal	Roof	Bucket	FS870 Anchor
	FS-ROOF-E	V-Line Bucket Roof Kit: FS99280-E Harness, 018-7005 VLL, FS870 Anchor	Universal	Roof	Bucket	FS870 Anchor
	020-3120	V-Line Bag Roof Kit: FS99280-E Harn, FS700-100 VLL, FS1118-DC Grab, FS88560-E Lan, FS870 Anchor, FS8185 Bag	Universal	Roof	Bag	FS870 Anchor

V-LINE Kit Options - Continued

PART NUMBER	DESCRIPTION	HARNESS SIZE	TYPE	STORAGE	OPTION
SW130-E	V-Line Bag Kit: FS99280-E Harness, FS-FSP1411-W SRL, FS811-6 Anchor, FS8150 Bag	Universal	Compliance	Bag	FS811-6 Anchor
021-3144	V-Line Bag Kit: FS99280-E Harness, FS-FSP1411-W SRL, FS811-3 Anchor, FS8150 Bag	Universal	Compliance	Bag	FS811-3 Anchor
020-3075	V-Line Bag Roof Kit: FS99185-E Harn, FS700-50 VLL, FS1120 Grab, FS88560-E Lanyard, FS870 Anchor, FS8150 Bag	Universal	Roof	Bag	FS870 Anchor
019-3037	V-Line Bag Roof Kit: FS99185-E Harness, 018-7005 VLL, FS870 Anchor, FS8185 Bag	Universal	Roof	Bag	FS870 Anchor
020-3131	V-Line Bag Roof Kit: FS99185-E Harn, FS700-50 VLL, FS1118-DC Grab, FS88560-E3 Lan, FS870 Anchor, FS8185 Bag	Universal	Roof	Bag	FS870 Anchor
FS120-E/ 1118DC-BP	V-Line Bag Roof Kit: FS99280-E Harn, FS700-50 VLL, FS1118-DC Grab, FS88560-E Lan, FS870 Anchor, FS8185 Bag	Universal	Roof	Bag	FS870 Anchor
FS-EX6000-DL	V-Line Bag Roof Kit: FS99280-E Harn, FS700-50 VLL, FS1120 Grab, FS88561-E Lanyard, FS870 Anchor, FS8150 Bag	Universal	Roof	Bag	FS870 Anchor
FS-ROOF-E-BP	V-Line Bag Roof Kit: FS99280-E Harness, 018-7005 VLL, FS870 Anchor, FS8185 Bag	Universal	Roof	Bag	FS870 Anchor
FS121-E	V-Line Bag Roof Kit: FS99280-E Harness, FS700-50GA VLL, FS88560-E Lanyard, FS870 Anchor, FS8175 Bag	Universal	Roof	Bag	FS870 Anchor
FS-EX6000	V-Line Bag Roof Kit: FS99280-E Harn, FS700-50 VLL, FS1120 Grab, FS88560-E Lanyard, FS870 Anchor, FS8150 Bag	Universal	Roof	Bag	FS870 Anchor
FS-ROOF-E-BAG	V-Line Bag Roof Kit: FS99280-E Harness, 018-7005 VLL, FS870 Anchor, FS8175 Bag	Universal	Roof	Bag	FS870 Anchor
020-3113	V-Line Bag Roof Kit: FS99280-E Harness, 018-7005 VLL, FS870 Anchor, FS8150 Bag	Universal	Roof	Bag	FS870 Anchor
021-3216	V-Line Bag Roof Kit: FS99185-E Harness, 018-7005 VLL, FS870 Anchor, FS8175 Bag	Universal	Roof	Bag	FS870 Anchor

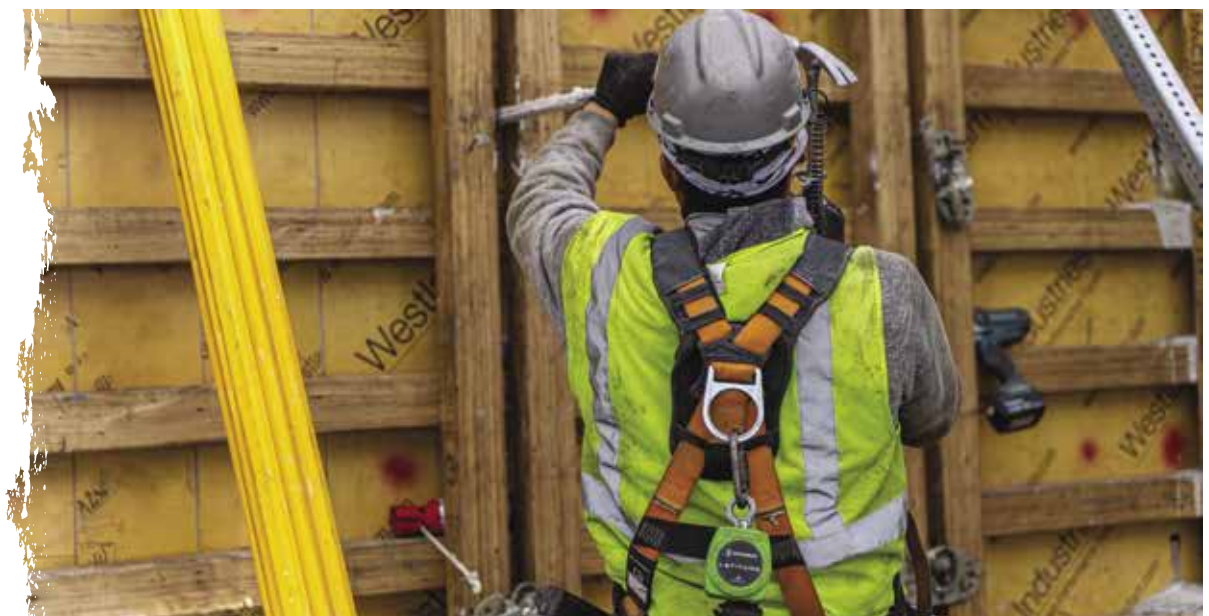

**PRO+ Combo Options**

	PART NUMBER	DESCRIPTION	HARNESS SIZE	TYPE	STORAGE	OPTION
1	FS152-S/M	PRO+ Bag Combo: FS-FLEX185-S/M Harness, FS590 Lanyard, FS8150 Bag	Small/Medium	Compliance	Bag	Lanyard
	FS152-L/XL	PRO+ Bag Combo: FS-FLEX185-L/XL Harness, FS590 Lanyard, FS8150 Bag	Large/X-Large	Compliance	Bag	Lanyard
	FS152-2X	PRO+ Bag Combo: FS-FLEX185-2X Harness, FS590 Lanyard, FS8150 Bag	2X-Large	Compliance	Bag	Lanyard

**PRO Combo Options**

	PART NUMBER	DESCRIPTION	HARNESS SIZE	TYPE	STORAGE	OPTION
1	FS144-S/M	PRO Bag Combo: FS185-S/M Harness, FS-FSP14075-W SRL, FS8150 Bag	Small/Medium	Compliance	Bag	SRL
	FS144-L/XL	PRO Bag Combo: FS185-L/XL Harness, FS-FSP14075-W SRL, FS8150 Bag	Large/X-Large	Compliance	Bag	SRL
	FS144-2X	PRO Bag Combo: FS185-2X Harness, FS-FSP14075-W SRL, FS8150 Bag	2X-Large	Compliance	Bag	SRL
2	019-3039	PRO Bag Combo: FS185-XS Harness, 019-5052 SRL, FS8150 Bag	X-Small	Compliance	Bag	SRL
	019-3040	PRO Bag Combo: FS185-S/M Harness, 019-5052 SRL, FS8150 Bag	Small/Medium	Compliance	Bag	SRL
	019-3041	PRO Bag Combo: FS185-L/XL Harness, 019-5052 SRL, FS8150 Bag	Large/X-Large	Compliance	Bag	SRL
	019-3042	PRO Bag Combo: FS185-2X Harness, 019-5052 SRL, FS8150 Bag	2X-Large	Compliance	Bag	SRL
	019-3043	PRO Bag Combo: FS185-3X Harness, 019-5052 SRL, FS8150 Bag	3X-Large	Compliance	Bag	SRL
3	019-3005	PRO Bag Combo: FS185-XS Harness, 018-5004 SRL, FS8150 Bag	X-Small	Compliance	Bag	SRL
	019-3006	PRO Bag Combo: FS185-S/M Harness, 018-5004 SRL, FS8150 Bag	Small/Medium	Compliance	Bag	SRL
	019-3007	PRO Bag Combo: FS185-L/XL Harness, 018-5004 SRL, FS8150 Bag	Large/X-Large	Compliance	Bag	SRL
	019-3008	PRO Bag Combo: FS185-2X Harness, 018-5004 SRL, FS8150 Bag	2X-Large	Compliance	Bag	SRL
	019-3009	PRO Bag Combo: FS185-3X Harness, 018-5004 SRL, FS8150 Bag	3X-Large	Compliance	Bag	SRL
4	FS143-XS	PRO Bag Combo: FS185-XS Harness, 018-5009 SRL, FS8150 Bag	X-Small	Compliance	Bag	SRL
	FS143-S/M	PRO Bag Combo: FS185-S/M Harness, 018-5009 SRL, FS8150 Bag	Small/Medium	Compliance	Bag	SRL
	FS143-L/XL	PRO Bag Combo: FS185-L/XL Harness, 018-5009 SRL, FS8150 Bag	Large/X-Large	Compliance	Bag	SRL
	FS143-2X	PRO Bag Combo: FS185-2X Harness, 018-5009 SRL, FS8150 Bag	2X-Large	Compliance	Bag	SRL
	FS143-3X	PRO Bag Combo: FS185-3X Harness, 018-5009 SRL, FS8150 Bag	3X-Large	Compliance	Bag	SRL

PRO Combo Options - Continued

	PART NUMBER	DESCRIPTION	HARNESS SIZE	TYPE	STORAGE	OPTION
5	FS146-XS	PRO Bag Combo: FS185-XS Harness, FS-FSP1407-W SRL, FS8150 Bag	X-Small	Compliance	Bag	SRL
	FS146-S/M	PRO Bag Combo: FS185-S/M Harness, FS-FSP1407-W SRL, FS8150 Bag	Small/Medium	Compliance	Bag	SRL
	FS146-L/XL	PRO Bag Combo: FS185-L/XL Harness, FS-FSP1407-W SRL, FS8150 Bag	Large/X-Large	Compliance	Bag	SRL
	FS146-2X	PRO Bag Combo: FS185-2X Harness, FS-FSP1407-W SRL, FS8150 Bag	2X-Large	Compliance	Bag	SRL
	FS146-3X	PRO Bag Combo: FS185-3X Harness, FS-FSP1407-W SRL, FS8150 Bag	3X-Large	Compliance	Bag	SRL
6	FS139-DL-XS	PRO Bag Combo: FS185-XS Harness, FS566 Lanyard, FS8150 Bag	X-Small	Compliance	Bag	Lanyard
	FS139-DL-S/M	PRO Bag Combo: FS185-S/M Harness, FS566 Lanyard, FS8150 Bag	Small/Medium	Compliance	Bag	Lanyard
	FS139-DL-L/XL	PRO Bag Combo: FS185-L/XL Harness, FS566 Lanyard, FS8150 Bag	Large/X-Large	Compliance	Bag	Lanyard
	FS139-DL-2X	PRO Bag Combo: FS185-2X Harness, FS566 Lanyard, FS8150 Bag	2X-Large	Compliance	Bag	Lanyard
	FS139-DL-3X	PRO Bag Combo: FS185-3X Harness, FS566 Lanyard, FS8150 Bag	3X-Large	Compliance	Bag	Lanyard
7	FS139-XS	PRO Bag Combo: FS185-XS Harness, FS565 Lanyard, FS8150 Bag	X-Small	Compliance	Bag	Lanyard
	FS139-S/M	PRO Bag Combo: FS185-S/M Harness, FS565 Lanyard, FS8150 Bag	Small/Medium	Compliance	Bag	Lanyard
	FS139-L/XL	PRO Bag Combo: FS185-L/XL Harness, FS565 Lanyard, FS8150 Bag	Large/X-Large	Compliance	Bag	Lanyard
	FS139-2X	PRO Bag Combo: FS185-2X Harness, FS565 Lanyard, FS8150 Bag	2X-Large	Compliance	Bag	Lanyard
	FS139-3X	PRO Bag Combo: FS185-3X Harness, FS565 Lanyard, FS8150 Bag	3X-Large	Compliance	Bag	Lanyard
8	FS141-D-S/M	PRO Bag Combo: FS185-S/M Harness, FS561 Lanyard, FS8150 Bag	Small/Medium	Compliance	Bag	Lanyard
	FS141-D-L/XL	PRO Bag Combo: FS185-L/XL Harness, FS561 Lanyard, FS8150 Bag	Large/X-Large	Compliance	Bag	Lanyard
	FS141-D-2X	PRO Bag Combo: FS185-2X Harness, FS561 Lanyard, FS8150 Bag	2X-Large	Compliance	Bag	Lanyard

PRO Combo Options - Continued

	PART NUMBER	DESCRIPTION	HARNESS SIZE	TYPE	STORAGE	OPTION
9	FS147-S/M	PRO Bag Combo: FS185-S/M Harness, FS456 Lanyard, FS8150 Bag	Small/Medium	Compliance	Bag	Lanyard
	FS147-L/XL	PRO Bag Combo: FS185-L/XL Harness, FS456 Lanyard, FS8150 Bag	Large/X-Large	Compliance	Bag	Lanyard
	FS147-2X	PRO Bag Combo: FS185-2X Harness, FS456 Lanyard, FS8150 Bag	2X-Large	Compliance	Bag	Lanyard
10	FS133-DL-S/M	PRO Bag Combo: FS185-S/M Harness, FS581 Lanyard, FS8150 Bag	Small/Medium	Compliance	Bag	Lanyard
	FS133-DL-L/XL	PRO Bag Combo: FS185-L/XL Harness, FS581 Lanyard, FS8150 Bag	Large/X-Large	Compliance	Bag	Lanyard
	FS133-DL-2X	PRO Bag Combo: FS185-2X Harness, FS581 Lanyard, FS8150 Bag	2X-Large	Compliance	Bag	Lanyard
11	019-3027	PRO Bag Combo: FS185-S/M Harness, FS560-AJ Lanyard, FS8150 Bag	Small/Medium	Compliance	Bag	Lanyard
	019-3028	PRO Bag Combo: FS185-L/XL Harness, FS560-AJ Lanyard, FS8150 Bag	Large/X-Large	Compliance	Bag	Lanyard
	019-3029	PRO Bag Combo: FS185-2X Harness, FS560-AJ Lanyard, FS8150 Bag	2X-Large	Compliance	Bag	Lanyard
12	FS133-XS	PRO Bag Combo: FS185-XS Harness, FS580 Lanyard, FS8150 Bag	X-Small	Compliance	Bag	Lanyard
	FS133-S/M	PRO Bag Combo: FS185-S/M Harness, FS580 Lanyard, FS8150 Bag	Small/Medium	Compliance	Bag	Lanyard
	FS133-L/XL	PRO Bag Combo: FS185-L/XL Harness, FS580 Lanyard, FS8150 Bag	Large/X-Large	Compliance	Bag	Lanyard
	FS133-2X	PRO Bag Combo: FS185-2X Harness, FS580 Lanyard, FS8150 Bag	2X-Large	Compliance	Bag	Lanyard
	FS133-3X	PRO Bag Combo: FS185-3X Harness, FS580 Lanyard, FS8150 Bag	3X-Large	Compliance	Bag	Lanyard
13	FS141-XS	PRO Bag Combo: FS185-XS Harness, FS560 Lanyard, FS8150 Bag	X-Small	Compliance	Bag	Lanyard
	FS141-S/M	PRO Bag Combo: FS185-S/M Harness, FS560 Lanyard, FS8150 Bag	Small/Medium	Compliance	Bag	Lanyard
	FS141-L/XL	PRO Bag Combo: FS185-L/XL Harness, FS560 Lanyard, FS8150 Bag	Large/X-Large	Compliance	Bag	Lanyard
	FS141-2X	PRO Bag Combo: FS185-2X Harness, FS560 Lanyard, FS8150 Bag	2X-Large	Compliance	Bag	Lanyard
	FS141-3X	PRO Bag Combo: FS185-3X Harness, FS560 Lanyard, FS8150 Bag	3X-Large	Compliance	Bag	Lanyard

PRO Combo Options - Continued

PART NUMBER	DESCRIPTION	HARNESS SIZE	TYPE	STORAGE	OPTION	
14	019-3054	PRO Bag Combo: FS185-XS Harness, FS560-3 Lanyard, FS8150 Bag	X-Small	Compliance	Bag	Lanyard
	019-3055	PRO Bag Combo: FS185-S/M Harness, FS560-3 Lanyard, FS8150 Bag	Small/Medium	Compliance	Bag	Lanyard
	019-3056	PRO Bag Combo: FS185-L/XL Harness, FS560-3 Lanyard, FS8150 Bag	Large/X-Large	Compliance	Bag	Lanyard
	019-3057	PRO Bag Combo: FS185-2X Harness, FS560-3 Lanyard, FS8150 Bag	2X-Large	Compliance	Bag	Lanyard
	019-3058	PRO Bag Combo: FS185-3X Harness, FS560-3 Lanyard, FS8150 Bag	3X-Large	Compliance	Bag	Lanyard
15	FS128-S/M	PRO Bag Combo: FS285-S/M Harness, FS560 Lanyard, FS8150 Bag	Small/Medium	Compliance	Bag	Lanyard
	FS128-L/XL	PRO Bag Combo: FS285-L/XL Harness, FS560 Lanyard, FS8150 Bag	Large/X-Large	Compliance	Bag	Lanyard
	FS128-2X	PRO Bag Combo: FS285-2X Harness, FS560 Lanyard, FS8150 Bag	2X-Large	Compliance	Bag	Lanyard
16	FS126-XS	PRO Bag Combo: FS280-XS Harness, FS560 Lanyard, FS8150 Bag	X-Small	Compliance	Bag	Lanyard
	FS126-S/M	PRO Bag Combo: FS280-S/M Harness, FS560 Lanyard, FS8150 Bag	Small/Medium	Compliance	Bag	Lanyard
	FS126-L/XL	PRO Bag Combo: FS280-L/XL Harness, FS560 Lanyard, FS8150 Bag	Large/X-Large	Compliance	Bag	Lanyard
	FS126-2X	PRO Bag Combo: FS280-2X Harness, FS560 Lanyard, FS8150 Bag	2X-Large	Compliance	Bag	Lanyard
	FS126-3X	PRO Bag Combo: FS280-3X Harness, FS560 Lanyard, FS8150 Bag	3X-Large	Compliance	Bag	Lanyard
17	FS129-4-S/M	PRO Combo: FS280-S/M Harness, FS560-4 Lanyard, Plastic Bag	Small/Medium	Compliance	Plastic Bag	Lanyard
	FS129-4-L/XL	PRO Combo: FS280-L/XL Harness, FS560-4 Lanyard, Plastic Bag	Large/X-Large	Compliance	Plastic Bag	Lanyard
	FS129-4-2X	PRO Combo: FS280-2X Harness, FS560-4 Lanyard, Plastic Bag	2X-Large	Compliance	Plastic Bag	Lanyard

## V-LINE Combo Options

PART NUMBER	DESCRIPTION	HARNESS SIZE	TYPE	STORAGE	OPTION
020-3059	V-Line Bucket Combo: FS99280-E Harness, FS88560-E Lanyard	Universal	Compliance	Bucket	SRL
020-3072	V-Line Bag Combo: FS99185-E Harness, 019-5045 SRL, FS8150 Bag	Universal	Compliance	Bag	SRL
FS126-E-DL	V-Line Bag Combo: FS99280-E Harness, FS88561-E Lanyard, FS8150 Bag	Universal	Compliance	Bag	Lanyard
FS127-E	V-Line Bag Combo: FS99285-E Harness, FS88560-E Lanyard, FS8150 Bag	Universal	Compliance	Bag	Lanyard
FS141-E	V-Line Bag Combo: FS99185-E Harness, FS88560-E Lanyard, FS8150 Bag	Universal	Compliance	Bag	Lanyard
FS126-E-3D	V-Line Bag Combo: FS99281-E Harness, FS88560-E Lanyard, FS8150 Bag	Universal	Compliance	Bag	Lanyard
019-3036	V-Line Combo: FS99185-E Harness, FS88560-E Lanyard, Plastic Bag	Universal	Compliance	Plastic Bag	Lanyard
FS126-E	V-Line Bag Combo: FS99280-E Harness, FS88560-E Lanyard, FS8150 Bag	Universal	Compliance	Bag	Lanyard
020-3129	V-Line Bag Combo: FS99280-E Harness, FS88580 Lanyard, FS8150 Bag	Universal	Compliance	Bag	Lanyard
019-3034	V-Line Bag Combo: FS99185-E Harness, FS88560-E Lanyard, FS8125 Bag	Universal	Compliance	Bag	Lanyard
019-3035	V-Line Bag Combo: FS99280-E Harness, FS88561-E Lanyard, FS8125 Bag	Universal	Compliance	Bag	Lanyard
FS129-E	V-Line Bag Combo: FS99280-E Harness, FS88560-E Lanyard, Plastic Bag	Universal	Compliance	Plastic Bag	Lanyard





# ACCESSORIES

In fall protection, accessories are not just for decoration. They are an integral part of the safety system, each with its own job to do, making the product more efficient or versatile. Bonus, ours look good while doing it.



## SRL COMPONENTS

Selection of specialized brackets, anchor points and tagline used with self-retracting lifelines.



## CARABINERS

Aluminum and steel carabiners used in part of a personal fall protection system.



## BAGS

Personal fall protection equipment storage and travel bags.



## BELTS & PADS

Replacement and positioning belts, assortment of comfort pads and more.



## TRIPLE ACTION RETRACTABLE BRACKET

9013

The Triple Action Retractable Bracket installs behind the dorsal D-ring webbing and gate swings open for quick installation or removal of the SRL.

- Aluminum bracket body
- Ultra-secure connection
- Steel swing gate for easy access
- Use with single and dual SRLs
- Minimum Breaking Strength: 5,000 lbs.
- ANSI Z359.12

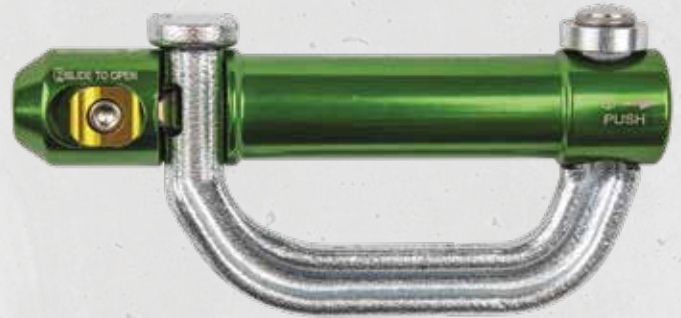

## Retractable Steel Bracket

SW-9012

- Quick installation
- All steel with secure slide gate
- Use with single and dual SRLs
- Minimum Breaking Strength: 5,000 lbs.
- ANSI Z359.12



## Cab Mount Bracket

019-4017

- Stainless steel anchor bracket & fasteners
- Built for use in order picker fork lifts
- Minimum Breaking Strength: 5,000 lbs.
- OSHA 1910.140, 1910.66, 1926.502



## 14' SRL Tagline Rope

020-9012

- 5mm weather resistant rope
- Yellow color for easy visibility
- Breaking Strength: 550 lbs.

### Tagline Rope Options

PART NUMBER	LENGTH
020-9012	14 feet
020-9013	21 feet
020-9014	34 feet
020-9015	51 feet



## ALUMINUM BOA CARABINER WITH CAPTIVE PIN

FS1018

The Aluminum Boa Carabiner is our lightweight aluminum carabiner with approximately 40% weight savings over steel. Ideal for climbing jobs where weight makes a difference.

- Ultra light aluminum
- Optional captive pin
- Twist lock gate
- Large gate opening 2"
- ANSI Z359.12



### Large Steel Carabiner with Captive Pin

FS1026

- For the toughest jobs
- Optional captive pin
- Twist lock gate
- Large gate opening 2.13"
- ANSI Z359.12



### Steel Boa Carabiner with Captive Pin

FS1017

- For large jobs
- Optional captive pin
- Twist lock gate
- Large gate opening 2.01"
- ANSI Z359.12



### Steel Carabiner with Captive Pin

FS1025

- For midsize jobs
- Optional captive pin
- Twist lock gate
- Gate opening 1.18"
- ANSI Z359.12



### Small Steel Carabiner with Captive Pin

021-9039

- Small and mighty
- Optional captive pin
- Twist lock gate
- Gate opening .75"
- ANSI Z359.12



### Small Aluminum Carabiner

FS1016-GR

- Ultra light aluminum
- Twist lock gate
- Gate opening .75"
- ANSI Z359.12



### Small Steel Carabiner

FS1015

- Small and mighty
- Twist lock gate
- Gate opening .75"
- ANSI Z359.12



### Oval Steel Triple Lock Carabiner

019-9002

- Ultra secure connection
- Triple lock gate
- Gate opening .5"
- ANSI Z359.12



### Small Aluminum Boa Carabiner

021-9068

- Versatile, ultra light
- Twist lock gate
- Gate opening .5"
- ANSI Z359.12



## HEAVY DUTY GEAR BAG - XL

FS8185

The Heavy Duty Gear Bag is the ideal bag for safe storage and transport of your complete fall protection system. Large opening allows for quick access and carry straps provide easy transportation.

- Heavy duty construction
- Backpack style carry straps
- Secure top drawstring closure
- Internal storage pockets
- Accessory D-rings



### 25" Duffel Bag

FS8175

- Heavy duty construction
- Web reinforced body
- Convenient top carry handles
- Secure zipper closure



### 23" Duffel Bag

PA-PK009

- Extra heavy duty construction
- Web reinforced body
- Convenient top carry handles
- Secure zipper closure
- Side storage pockets



### 20" Duffel Bag

FS8150

- Heavy duty construction
- Web reinforced body
- Convenient top carry handles
- Secure zipper closure



### 13" Duffel Bag

FS8125

- Heavy duty construction
- Web reinforced body
- Convenient top carry handles
- Secure zipper closure



## PRO WAIST PAD & BELT

FS2011

The PRO Waist Pad & Belt is perfect for the conversion of a full body harness into a construction harness. Add padded comfort plus versatility with positioning capabilities.

- Large padded waist area for comfort
- Positioning belt with steel side D-rings
- Tongue buckle webbed belt securely holds pad
- OSHA 1926.502

### Waist Belt Sizes

X-SMALL	SMALL	MEDIUM	LARGE	XLARGE	2X	3X	4X
FS2011-XS	FS2011-S	FS2011-M	FS2011-L	FS2011-XL	FS2011-2X	FS2011-3X	FS2011-4X



### Positioning Belt

**FSBELT-2D-RINGS**

- Steel positioning side D-rings
- Webbed belt with tongue buckle fit
- Webbing keeper

#### Positioning Belt Options

PART NUMBER	SIZE
FSBELT-2D-RINGS-S	Small
FSBELT-2D-RINGS-M	Medium
FSBELT-2D-RINGS-L	Large
FSBELT-2D-RINGS-XL	X-Large
FSBELT-2D-RINGS-2X	2X



### Replacement Belt

**021-9043**

- Webbed belt with easy tongue buckle fit
- Range of adjustment with 7 grommets
- Sturdy webbing for use with tool bags
- Webbing keeper

#### Replacement Belt Options

PART NUMBER	SIZE
021-9041	X-Small
021-9042	Small
021-9043	Medium
021-9044	Large
021-9045	X-Large
021-9046	2X
021-9047	3X
021-9048	4X



## Comfort Leg Pads

**SW111**

- Velcro closure system
- Open air mesh padding
- Removable and adjustable
- Fits most harness legs



## Replacement Lanyard Keepers

**021-9038**

- Installs easily to any size or style harness
- Durable, built-to-last construction
- Split D-ring design protects keeper from damage
- ANSI Z359.14



## Removable Shoulder Pad

**021-9070**

- Durable poly/mesh outer layer
- Anti-bacterial molded padding
- Stretch mesh linings
- 5 secure attachment points
- Fits on most standard harnesses





# MATERIAL HANDLING

When you need to move materials on the job, we provide a helping hand. Our design and engineering innovation partnered with our fall protection experience make jobsite lifting easier and more efficient.



## SOLAR SYSTEMS

These lightweight, portable systems are an innovation in lifting panels for the solar industry with maximum efficiency and safety.



## MODULITE SOLAR LIFT: 1-STORY

023-24000

The ModuLite Solar Lift is designed to lift solar panels and save time, increase efficiency and reduce fall risk for both personnel and material. The lightweight, modular system is easy to transport, assembles in minutes and is loaded with safety features such as a tilting top assembly, stabilizing bracket and pivoting base.

- Lightweight aluminum solar panel lifting system
- For structures up to 16' high
- Modular construction for easy transport and setup
- Does not require use of an additional ladder
- Tilt feature reduces fall risk when removing panel
- Manual rope pulley assembly to raise and lower loads
- Rope grab and carabiner included to lock rope assembly during lifting
- Secure system with top stabilizing bracket and tie-down strap
- Pivoting base with wide footprint and rubber pads for increased stability
- Convenient travel carrier
- Weight: 55.6 lbs.
- Working Load Limit: 200 lbs.

## ModuLite Solar Lift: 2-Story

023-24001

- For structures up to 31' high
- All the same features as 023-24000
- Weight: 74.8 lbs.
- Working Load Limit: 200 lbs.

## ModuLite Solar Lift: Industrial

023-24002

- Designed for commercial use
- For structures up to 63' high
- All the same features as 023-24000
- Weight: 113.2 lbs.
- Working Load Limit: 200 lbs.



### Track Segment

**023-24003**

- Aluminum track for ModuLite Solar Lift
- Replacement piece or extension to increase system height
- Weight: 4.8 lbs.
- Dimensions: 52" L x 18" W x 2" H

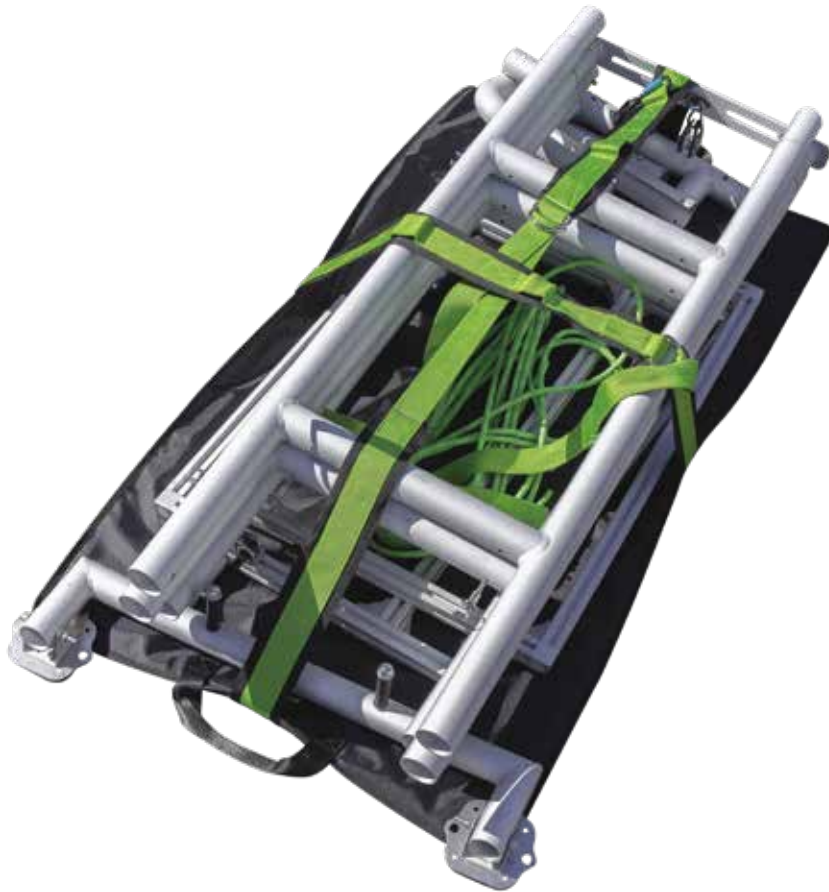



## CERTIFIED SERVICE & REPAIR

Keeping you safe on the job means keeping your equipment in action. Safewaze offers maintenance and repair services on worn or damaged equipment including:

- **Rescue Devices**



- **Confined Space**



- **SRLs**



### SAVE MONEY

A repair is significantly less expensive than a new unit, up to 50% or more savings

### MINIMIZE DOWNTIME

Service is completed in 5 days or less to keep your equipment in the field longer

### EXTEND PRODUCT LIFE

Regular maintenance increases the life of your safety equipment

### MAINTAIN SAFETY

Completed work is rigorously tested and certified to meet factory specifications

#### **SERVICE & REPAIR PROCESS**

Distributors and end users may send product to our North Carolina facility. Inspections are done at a flat fee (based on condition and size of item) with quote provided after inspection.

#### **BECOME AN AUTHORIZED CENTER**

Now training new providers to service Safewaze equipment.

To schedule service or inquire about training, contact us at [info@safewaze.com](mailto:info@safewaze.com).



# DELIVERING EXACTLY **WHAT YOU WANT,** THE WAY YOU WANT IT

## RESOURCES

Quality products aren't the only thing we deliver.

When it comes to protecting workers at height, we're always reaching for additional tools to do the job.

From easy-to-use inspection checklists and live-action training videos to practical FAQs and fall clearance calculations, we provide on-demand information at your fingertips. Call or visit us online to get the exact support you need.



## TRAINING EXPERTS

Training is a critical investment to protect workers at height, so we make it easy to keep your employees engaged year-round.

Available at your location or in our dedicated training facility, topics include ABCDs of fall protection, rescue, confined space, swing fall, product use, equipment inspection – and more.

We also provide demonstrations from our travel trailers and technical tripods as well as Competent Person certification classes.

Our dedicated experts are readily available to support you whenever and wherever - both on the ground and at height.



**WE  
PROTECT  
THE LIVES  
AND  
LIVELIHOODS  
OF  
WORKERS  
AT HEIGHT**



***SAFEWAZE***



***SAFEWAZE***

800-230-0319

INFO@SAFEWAZE.COM

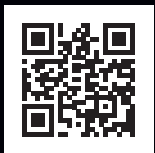

225 Wilshire Ave SW  
Concord NC 28025



U.S. MANUFACTURER

GET CONNECTED

